

FUZETEC

PPTC Resettable Fuse

2023
PPTC
Resettable Fuse
Catalog



Automotive



Internet of Things

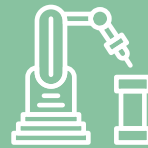

Industry 4.0



FUZETEC

Circuit Protection Solutions for Today & Tomorrow's Industries

C ontents

I	Overview
P.2-P.3	Company Profile
II	Fundamental
P.4	How Does the Resettable Fuse Work
P.5	PPTC Selection Guide
III	Application
P.6	Automotive
P.7	Smart Application/lot
P.8	Industry 4.0
P.9	Energy
IV	Radial Leaded
P.10-P.11	FRX
P.12-P.13	FRX90V
P.14-P.15	FRU
P.16-P.17	FRT
P.18-P.19	FUSB
P.20-P.21	FRG
P.22-P.23	FRHV
P.24-P.25	FRV
P.26-P.27	FRV277V
P.28-P.30	FRVL
V	Surface Mount
P.32-P.33	FSMD2920
P.34-P.35	FSMD240V _{AC}
P.36-P.37	FSMD2016
P.38-P.40	FSMD1812
P.41-P.42	FSMD1210
P.43-P.44	FSMD1206
P.45-P.46	FSMD0805
P.47-P.48	FSMD0603
P.49-P.50	FSMD0402
P.51-P.52	FSMD0201
VI	Low Rho
P.54-P.55	Low Rho FSMD1206
P.56-P.57	Low Rho FSMD0805
P.58-P.59	Low Rho FSMD0603
P.60-P.61	Low Rho FSMD0402
VII	Strap
P.62-P.64	Strap Series
VIII	High Temperature PPTC
P.66-P.67	FHT
P.68-P.69	FHE
P.70-P.72	FSMDH
IX	Customized Products
P.74	Automotive Products Energy & Telecom Products
X	Appendix
P.75-P.80	Cross Reference
P.81	Thermal Derating
P.82-P.83	SMD Product Solder Reflow Recommendations



FUZETEC

Committed to provide continuous circuit protection solutions to today's and tomorrow's electronic and electrical industries.

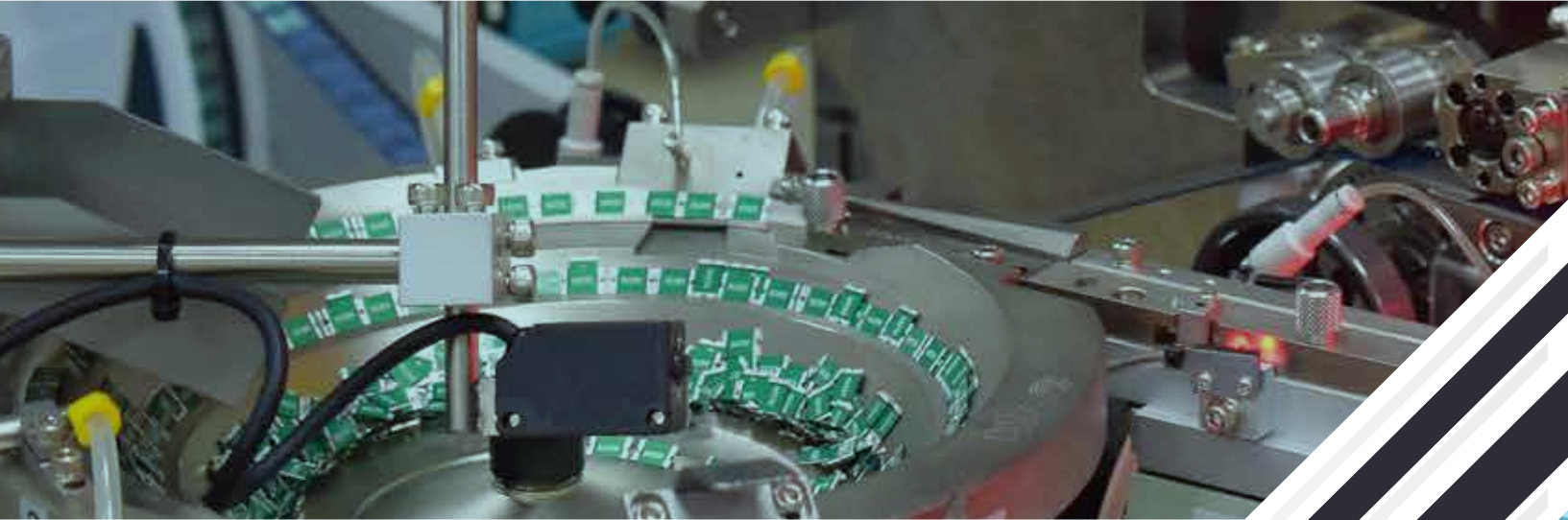

Fuzetec Technology

Founded in 1999 as a world-leading PTC resettable fuse manufacturer and designer, Fuzetec Technology Co., Ltd. (FUZETEC™) is committed to providing continuous circuit protection solutions to today's and tomorrow's electronic and electrical industries.

Fuzetec is a public company in Taiwan, Taipei Exchange Market (stock code: 6642)

Products & Application

With the most advanced Positive Temperature Coefficient (PTC) conductive polymer technologies, FUZETEC™ offers a wide variety of Polymeric PTC resettable fuses to fulfill the needs of modern demanding high-tech applications. They include but are not limited to: Automotives, Smart Applications & IoT, Industrial Control, Energy Solutions, etc.

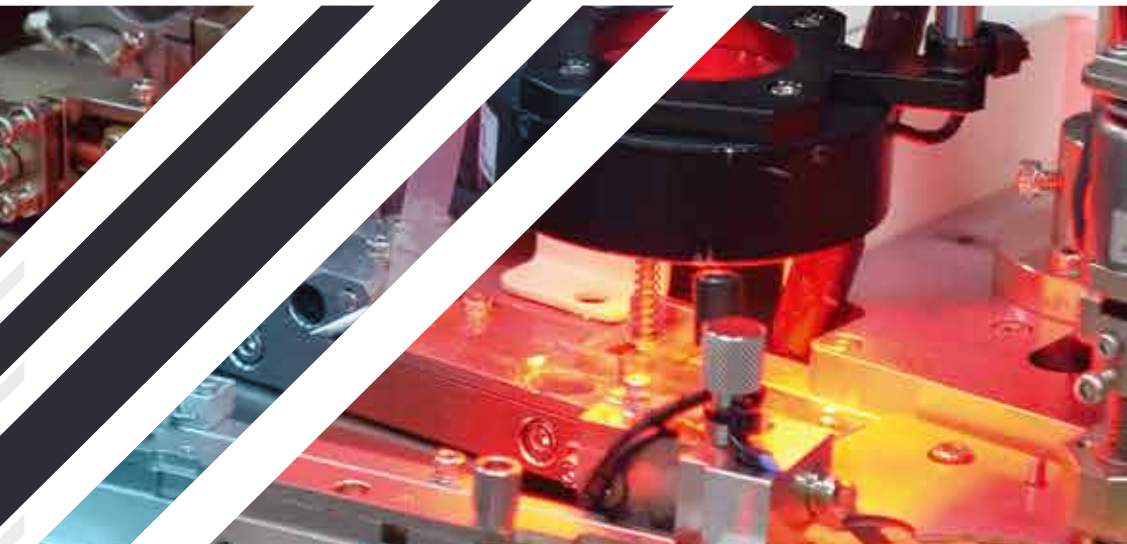

Safety, Quality and Customer Satisfaction

With third-party approvals (UL, C-UL, and TÜV), FUZETEC™ products are ensured to provide long-lasting safety and performance. From product design and development through manufacturing and quality control to delivery and shipment, Fuzetec Technology strictly implements IATF16949, ISO9001, and ISO14001 quality standards to assure its products' quality and consistency. Besides, as our long-term involvement in the Automotive industry, all FUZETEC™ automotive PPTC products are set to be tested and qualified using the AEC-Q200 specification for electronic components used in the Automotive industry. With continuous improvement, we are committed to providing top products and services to satisfy our customers' needs better. We strongly believe that excellent customer partnerships are the best and the only way to succeed in tomorrow's competitive business world.

Fuzetec Patents & Formula

FUZETEC™ holds 80 self-developed PTC patents (US x 33, TW x 29, CN x 18) and continues applying for multiple patents yearly. Our expertise in polymeric PTC material and product engineering provides us with the flexibility and advantage of new product development. With our patented PPTC formula, we can customize the product's electrical characteristics to meet customer-specific requirements and design the PPTC device structure for special applications. Fuzetec's technical know-how and engineering expertise are your solution provider for circuit protection.

NOTE : All Specifications subject to change without notice.

How Does the Resettable Fuse Work

FUZETEC™ resettable fuses are designed and made of patented novel polymeric PTC material in thin chip form, developed solely by FUZETEC™. With electrodes and leads attached on both sides, it is placed in series to protect a circuit. At “normal operating condition” the device remains at an extremely low resistance (milli-ohms) and allows the electrical current to flow through it without any restriction. When overcurrent conditions occur, the polymeric PTC material heats up and its resistance increases sharply. Such a sharp resistance increase (to an insulated status) cuts off the current in the circuit, and consequently protects the element and device in the circuit. Upon fault current being removed, the resettable fuse cools down and its resistance drops to the original extremely low value. The resettable fuse is “reset” and allows the current flow through the circuit again.

PPTC in Circuit

The typical PPTC application is to be used as a series component in a circuit.

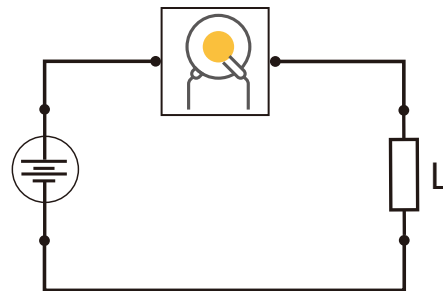

How It Works

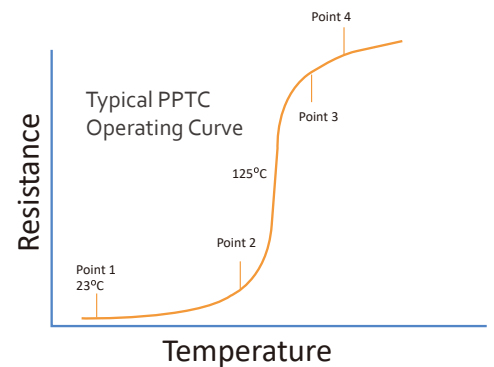
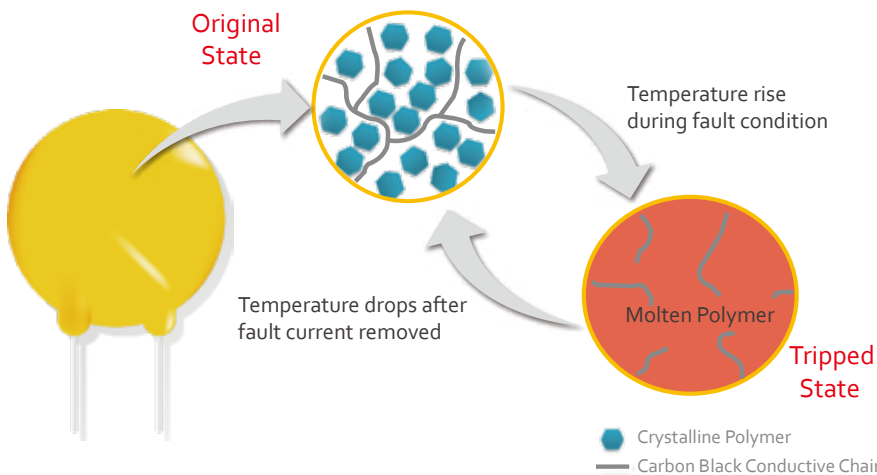

Basic Structure

- Epoxy Coating ■ Solder Layer
- Nickel Plated Copper Foil ■ PTC Element

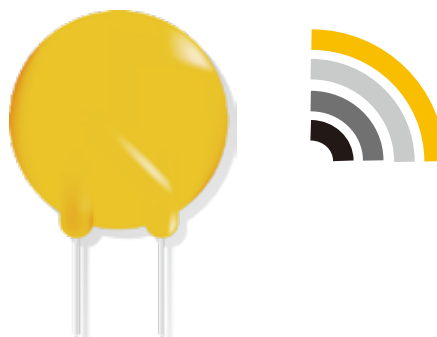

the PPTC Selection Guide

SELECTION GUIDE

1 Circuit Parameters

Determine your circuit parameters

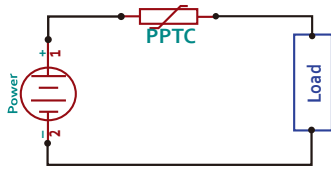

- Circuit Operating Current
- Maximum Operating Voltage
- Maximum Interrupt Current
- Maximum Ambient Operating Temperature

2 Voltage & Current Rating

Select a Fuzetec PPTC Device with proper electrical characteristics



V_{Max}/I_{Max} are the maximum voltage/current PPTC devices can withstand without damage

Hold Current (I_H) is the maximum current which a PPTC device will keep in low resistance state at 23°C

Trip Current (I_T) is the minimum current which a PPTC will trip at 23°C

Check the electrical characteristics table to ensure the PPTC device can match the circuit parameters

3 Ambient Temperature

Evaluate the maximum circuit operating ambient temperature



PPTC device is temperature sensitive, check the Thermal Derating table to verify the performance of PPTC device you select in Step 2 under different ambient temperature

4 Time to Trip

Determine Time to Trip for desired protection capabilities



Time to Trip is the amount of time that a PPTC device need to transfer low resistance state to high resistance "Tripped" state under fault condition.

Make sure the PPTC device to provide the desired protection capabilities

5 Check Dimension

Fuzetec provide a various types of packages and different dimensions, use the dimension table to compare the PPTC device you selected and your application's design consideration.

Glossary of Terms

- I_H : Hold Current - Maximum current at which the device will not trip at 23°C still air.
- I_T : Trip Current - Minimum current at which the device will always trip at 23°C still air.
- V_{Max} : Maximum voltage device can withstand without damage at its rated current.
- I_{Max} : Maximum fault current device can withstand without damage at rated voltage (V_{Max}).
- P_d : Maximum power dissipated from device when in tripped state in 23°C still air environment.
- R_{MIN} : Minimum device resistance at 23°C.
- R_{Max} : Maximum device resistance at 23°C.
- $R1_{Max}$: 1) Maximum resistance of device at 23°C measured 1 hour, after tripping for all product series;
2) or after REFLOW soldering of 260°C for 20 seconds for all SMD series;
3) or after WAVE soldering of 260°C for less than 5 seconds for all DIP series.

Special Note :

-In the event that TWO of the above three conditions were experienced once each, the acceptance criteria will become 1.3 times of $R1_{Max}$.

- In the event that ALL of the above three conditions were experienced once each, the acceptance criteria will become 1.5 times of $R1_{Max}$.

Automotive

Fuzetec has been partner of major automotive industry companies and OEMs for more than 10 years. We provide surface-mount, radial leaded and custom shaped chip/disc type PPTC resettable fuses for vehicle electronic equipment overcurrent circuit protections.

Automotive devices that operate under rigid environment need robust and reliable circuit protections, therefore our automotive product lineup are set to satisfy AEC-Q200 standard for electronic components used in the automotive industry.

Automotive PPTC Resettable Fuse Application

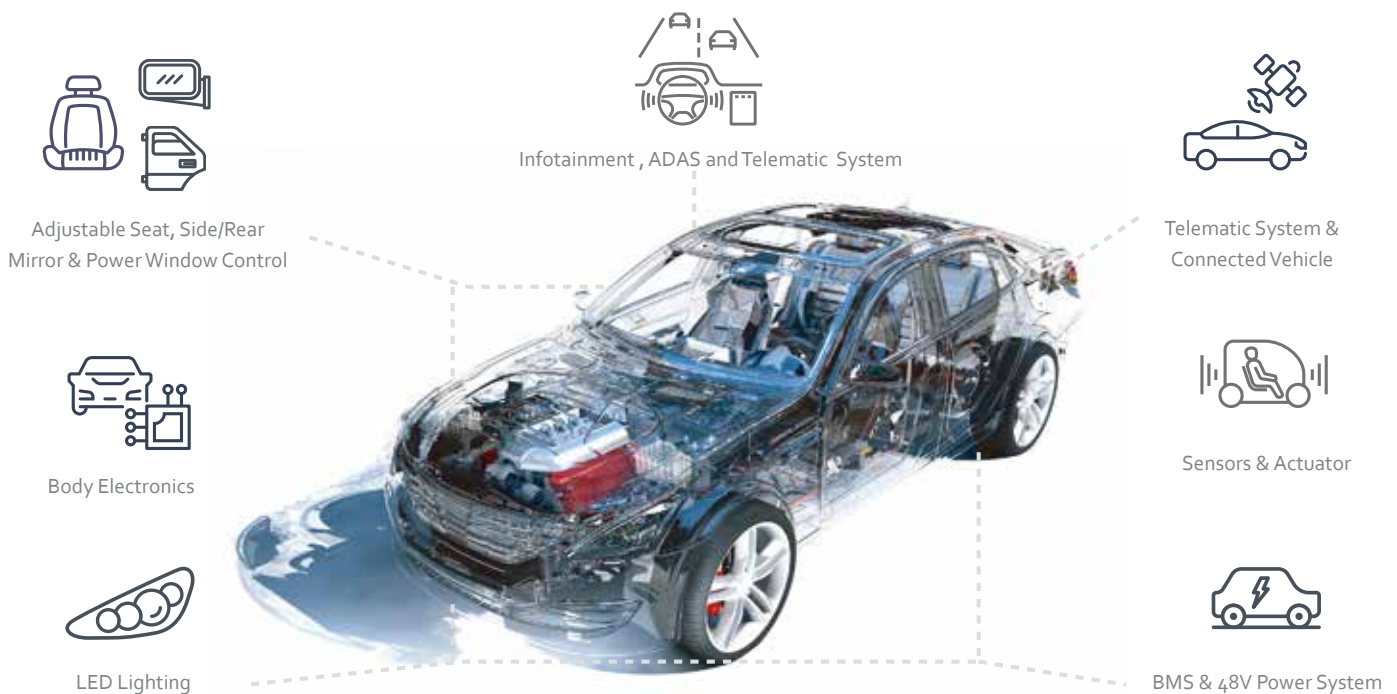

DC Motor Protection
Fuzetec Radial Leaded & Custom Shaped PPTC are ideal for DC motors employed in power operated automotive applications

Infotainment & ADAS System
As the vehicle system evolved to more intelligent and more complex application, Fuzetec offers a wide range of PPTC devices for application from In-Car multimedia to Advanced Driver Assistance System

48V Vehicle System
Fuzetec PPTC devices has developed test plan following AEC-Q200 guidelines to test for suitability and reliability for automotive industry's Latest voltage system & applications.

Feature

- IATF-16949 & AEC-Q200 Auto Industry Standard
- Applicable Resettable overcurrent circuit protection
- RoHS Compliant, Lead-Free and Halogen-Free(HF)
- Resistance range binned and sorted available
- Customized products Available

Application

- DC Motor & Motor Circuit Protection
- Sensors & Actuator
- Car Infotainment System, ADAS and Telematic System
- Automotive Body Electronics
- 48V Power System, BMS & Automotive Backup Batteries

Smart Application & IoT

From Network Infrastructure to IoT node & gateway; from Telecommunication Network to personal wearable devices. Fuzetec provides, a full range of overcurrent circuit protection solutions with its compact size, flexible design and cost competitive Polymeric Positive Temperature Coefficient (PPTC) resettable fuses.

For more than 10 years, Fuzetec has been providing test proven products to assist telecom equipment to meet test requirements of power cross and power induction surge defined by ITU-T, UL and Telecordia GR-1089 safety standards.

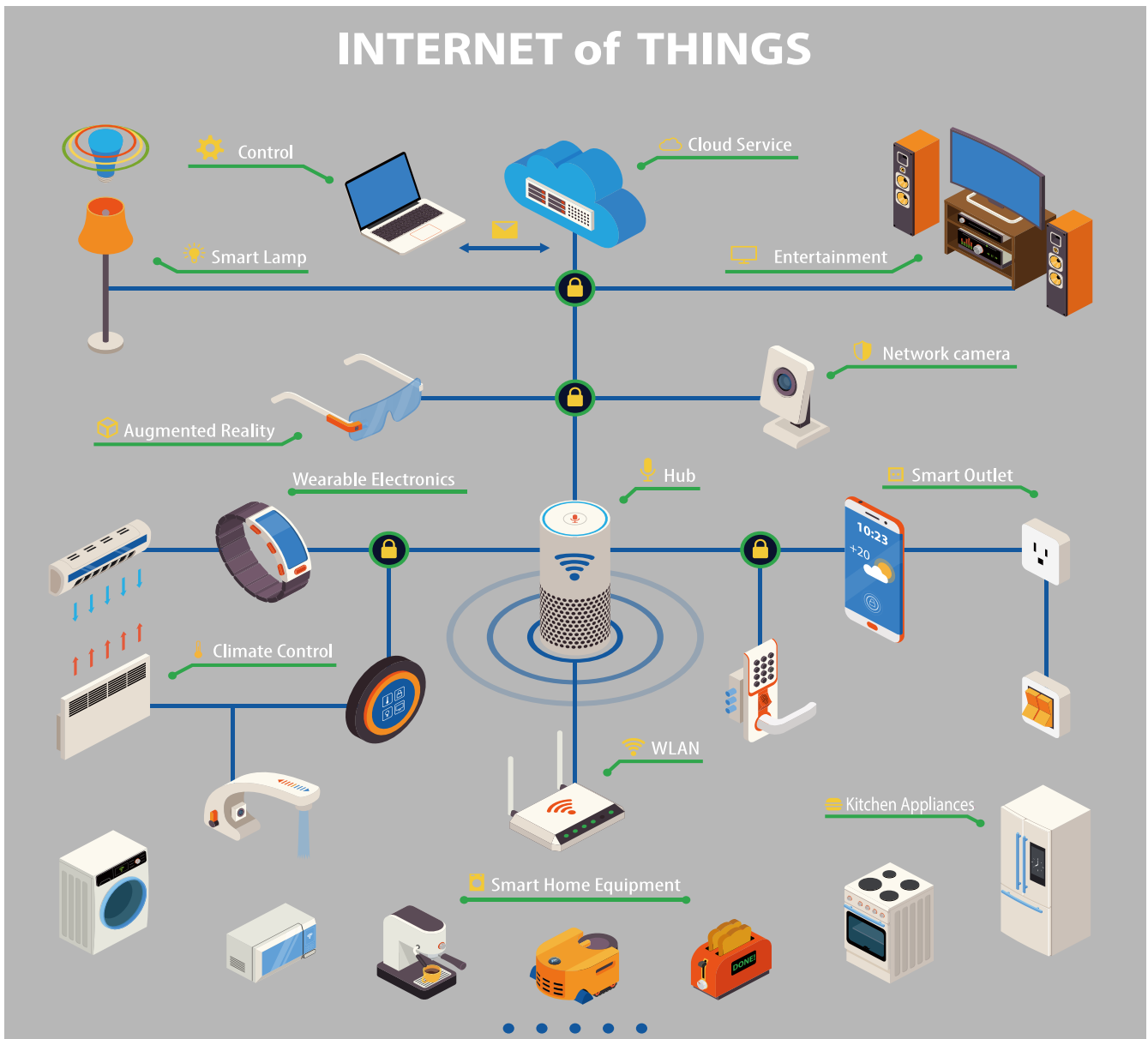

Feature:

Function-oriented design (High hold current/Fast trip time/High Ambient Temp/High Rated Voltage Current)
 RoHS Compliant, Lead-Free and Halogen-Free(HF)
 Resistance range binned and sorted available UL60950,
 UL497A, ITU-T K20/K21 & GR-1089 Compliant

Application:

Wearable & Smart Home Devices
 IoT Node & Gateway Devices
 Gaming & Entertainment
 Data Center & Network Solution
 Line Voltage Protection

Industry 4.0

Industry 4.0 is the current industrial transformation with automation, data exchanges, cloud, cyber-physical system, Big Data, and autonomous industrial techniques.

Fuzetec specializes in providing circuit protection with high reliability to Industrial, Transportation, and Medical markets under harsh and critical environment.

With the emerging trends of automation, electrification and digitalization of industrial technology, such as facility monitoring system, digital power supply, integrated security system and internet connectivity. Fuzetec solution meets industrial standard and offers reliable circuit protection for these industrial applications against electrical faults for 24/7 industrial operation.

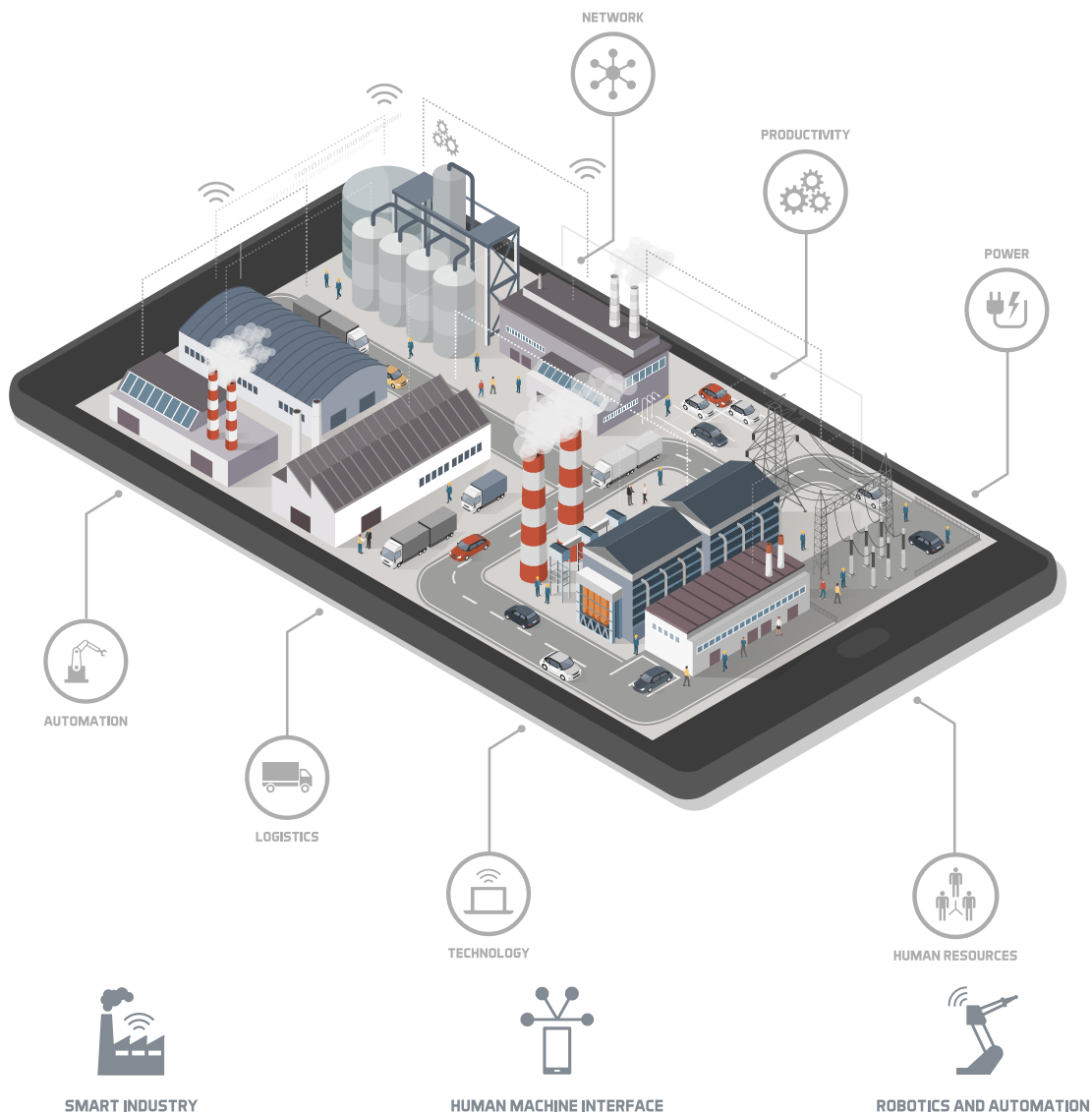

Feature

- Resettable overcurrent circuit protection
- RoHS Compliant, Lead-Free and Halogen-Free(HF)
- Resistance range binned and sorted available
- Function-oriented design (High hold current/Fast trip time/High Ambient Temp/High Rated Voltage Current)

Application

Automation & Control System, Industrial Machinery, Power Supply, Security Surveillance, Semiconductor Equipment, Fleet Control System Medical Equipment

Energy

The global renewable energy market is driven by government support. Improving battery technologies and reducing of initial cost has boosted the demand of battery energy storage systems. Integrate renewable sources with energy storage system can provide solution to on/off grid flexibility to reduce peak demand charges.

Fuzetec, a reliable partner for major Li-ion battery manufacturer in Asia, Europe and America, has developed a comprehensive line of circuit protection solutions for potential overcurrent and overheating condition. Fuzetec SMD, Low Rho SMD/Strap and custom PPTC disc devices offer flexibility for battery application with different performance characteristics.

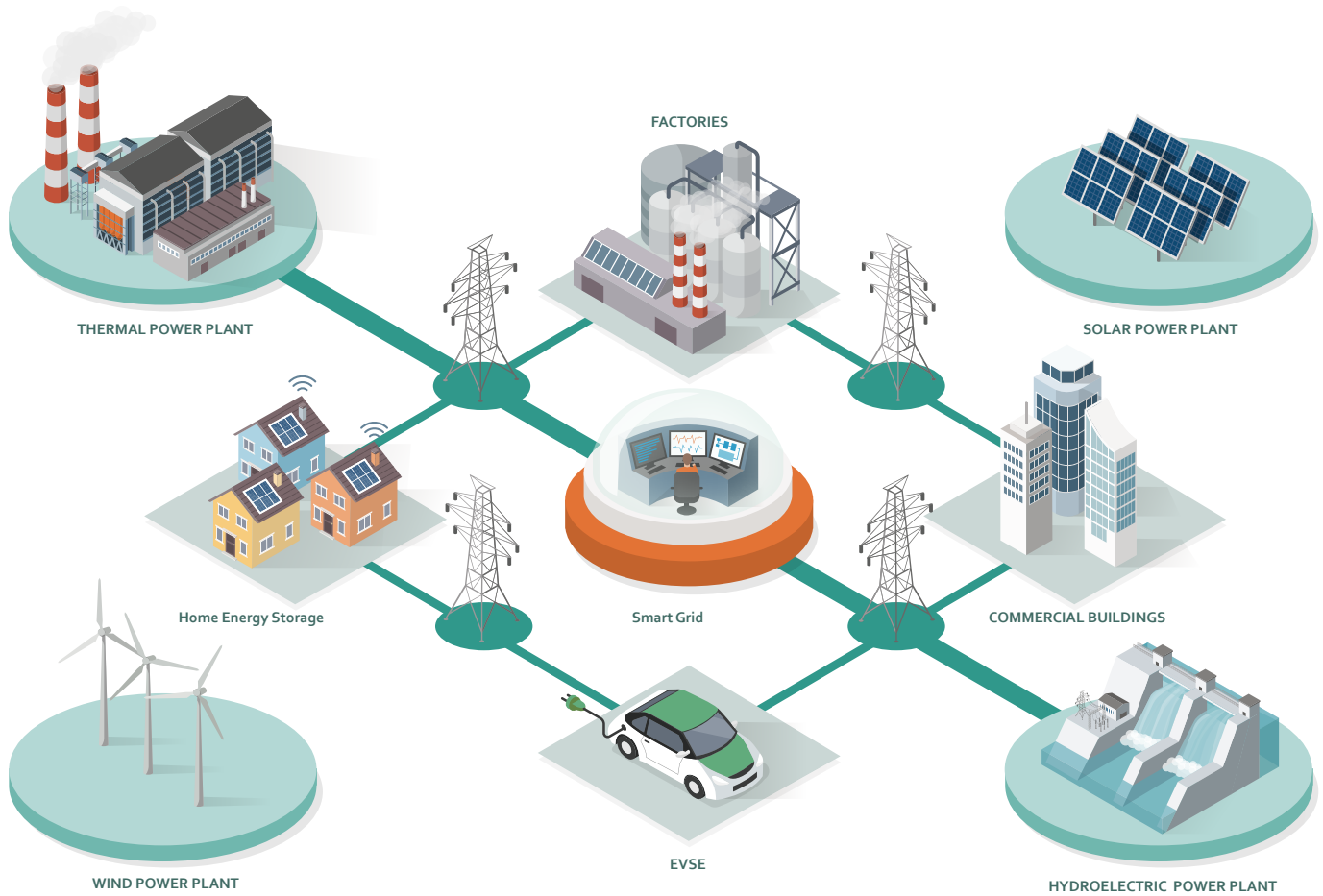

Feature:

- Ultra Low Resistance for Better Battery Life
- Resettable overcurrent circuit protection
- RoHS Compliant, Lead-Free and Halogen-Free(HF)
- Resistance range binned and sorted available

Application:

- Lithium Ion Battery Cell and Packs
- Battery PCM
- Smart Grid
- Solar Energy DC/AC Inverter

FRX Series



Application

Wide variety of electronic equipment

Product Features

Low hold current, Solid state Radial-leaded product ideal for up to 60V_{DC}



Operation Current

0.05A ~ 3.75A

Maximum Voltage

60V_{DC}



Temperature Range

-40°C to 85°C

Agency Recognition

AGENCY	AGENCY FILE NUMBER
	UL(E211981)
	C-UL(E211981)
	TÜV (R50004084)



Electrical Characteristics (23°C)

Part Number	Hold Current I _H , A	Trip Current I _T , A	Max. Time to trip at 5xI _H , s	Max. Current I _{MAX} , A	Rated Voltage V _{MAX} , V _{DC}	Typ. Power Pd, W	Resistance	
							R _{MIN} Ohms	R _{1MAX} Ohms
FRX005-60F	0.05	0.10	5.0	40	60	0.26	7.30	20.00
FRX010-60F	0.10	0.20	4.0	40	60	0.38	2.50	7.50
FRX017-60F	0.17	0.34	3.0	40	60	0.48	2.00	8.00
FRX020-60F	0.20	0.40	2.2	40	60	0.41	1.83	4.40
FRX025-60F	0.25	0.50	2.5	40	60	0.45	1.25	3.00
FRX030-60F	0.30	0.60	3.0	40	60	0.49	0.88	2.10
FRX040-60F	0.40	0.80	3.8	40	60	0.56	0.55	1.29
FRX050-60F	0.50	1.00	4.0	40	60	0.77	0.50	1.17
FRX065-60F	0.65	1.30	5.3	40	60	0.88	0.31	0.72
FRX075-60F	0.75	1.50	6.3	40	60	0.92	0.25	0.60
FRX090-60F	0.90	1.80	7.2	40	60	0.99	0.20	0.47
FRX110-60F	1.10	2.20	8.2	40	60	1.50	0.15	0.38
FRX135-60F	1.35	2.70	9.6	40	60	1.70	0.12	0.30
FRX160-60F	1.60	3.20	11.4	40	60	1.90	0.09	0.22
FRX185-60F	1.85	3.70	12.6	40	60	2.10	0.08	0.19
FRX250-60F	2.50	5.00	15.6	40	60	2.50	0.05	0.13
FRX300-60F	3.00	6.00	19.8	40	60	2.80	0.04	0.10
FRX375-60F	3.75	7.50	24.0	40	60	3.20	0.03	0.08

Thermal Derating for PPTC Device at Various Ambient Temperatures

TEMPERATURE	-40°C	-20°C	0°C	23°C	30°C	40°C	50°C	60°C	70°C	85°C
DERATING %	158%	138%	119%	100%	90%	81%	70%	60%	50%	36%

Typical Time-To-Trip at 23°C

- A = FRX005-60F J = FRX075-60F
- B = FRX010-60F K = FRX090-60F
- C = FRX017-60F L = FRX110-60F
- D = FRX020-60F M = FRX135-60F
- E = FRX025-60F N = FRX160-60F
- F = FRX030-60F O = FRX185-60F
- G = FRX040-60F P = FRX250-60F
- H = FRX050-60F Q = FRX300-60F
- I = FRX065-60F R = FRX375-60F

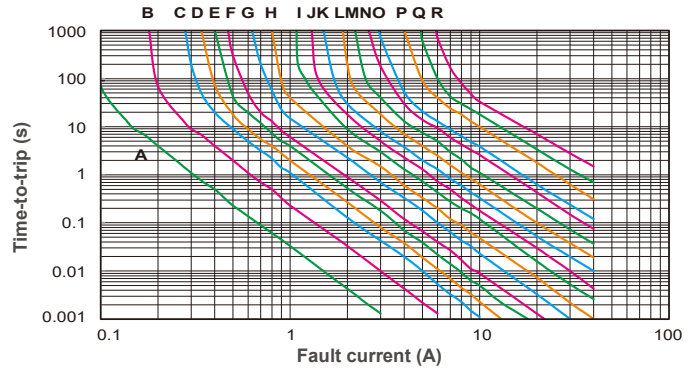

FRX Product Dimensions (mm)

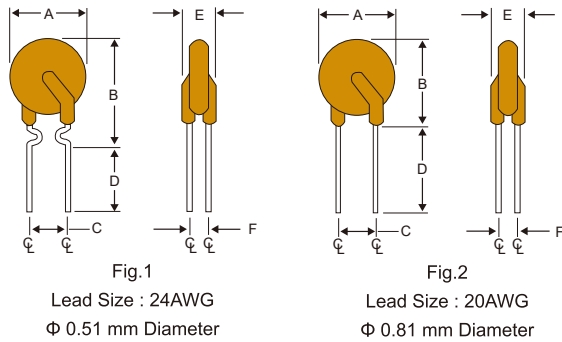

Part Number	Fig.	A	B	C	D	E	F
		Max.	Max.	Typ.	Min.	Max.	Typ.
FRX005-60F	1	7.4	12.7	5.1	7.6	3.1	1.1
FRX010-60F	1	7.4	12.7	5.1	7.6	3.1	1.1
FRX017-60F	1	7.4	12.7	5.1	7.6	3.1	1.1
FRX020-60F	1	7.4	12.7	5.1	7.6	3.1	1.1
FRX025-60F	1	7.4	12.7	5.1	7.6	3.1	1.1
FRX030-60F	1	7.4	12.7	5.1	7.6	3.1	1.1
FRX040-60F	1	7.6	13.5	5.1	7.6	3.1	1.1
FRX050-60F	1	7.9	13.7	5.1	7.6	3.1	1.1
FRX065-60F	1	9.7	14.5	5.1	7.6	3.1	1.1
FRX075-60F	1	10.4	15.2	5.1	7.6	3.1	1.1
FRX090-60F	1	11.7	15.8	5.1	7.6	3.1	1.1
FRX110-60F	2	13.0	18.0	5.1	7.6	3.1	1.4
FRX135-60F	2	14.5	19.6	5.1	7.6	3.1	1.4
FRX160-60F	2	16.3	21.3	5.1	7.6	3.1	1.4
FRX185-60F	2	17.8	22.9	5.1	7.6	3.1	1.4
FRX250-60F	2	21.3	26.4	10.2	7.6	3.1	1.4
FRX300-60F	2	24.9	30.0	10.2	7.6	3.1	1.4
FRX375-60F	2	28.5	33.5	10.2	7.6	3.1	1.4

Part Numbering System

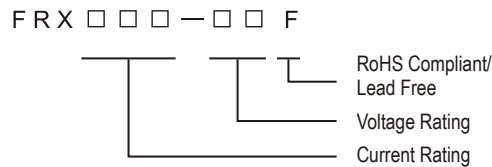

Part Marking System

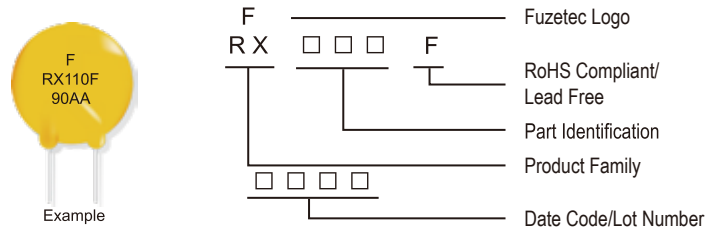

Package Information

Part Number	Standard Package
FRX005-60F~FRX050-60F	: 500 Pcs/Bag, 3.0K Reel/Tape
FRX065-60F~FRX090-60F	: 300 Pcs/Bag, 3.0K Reel/Tape
FRX110-60F	: 300 Pcs/Bag, 1.5K Reel/Tape
FRX135-60F~FRX185-60F	: 200 Pcs/Bag, 1.5K Reel/Tape
FRX250-60F~FRX375-60F	: 100 Pcs/Bag, 1.0K Reel/Tape

Physical specifications

Lead material	FRX005-60F~FRX040-60F Tin plated copper clad steel, 24 AWG.
	FRX050-60F~FRX090-60F Tin plated copper, 24 AWG.
	FRX110-60F~FRX375-60F Tin plated copper, 20 AWG.
Soldering characteristics	MIL-STD-202, Method 208E.
Insulating coating	Flame retardant epoxy, meets UL-94V-0 requirement.

Warning :



- Each product should be carefully evaluated and tested for their suitability of application.
- Operation beyond the specified maximum ratings or improper use may result in damage and possible electrical arcing and/or flame.
- PPTC device are intended for occasional overcurrent protection. Application for repeated overcurrent condition and/or prolonged trip are not anticipated.
- Avoid contact of PPTC device with chemical solvent, including some inert material such as silicone based oil, lubricant and etc. Prolonged contact will damage the device performance.
- Additional protection mechanism are strongly recommended to be used in conjunction with the PPTC device for protection against abnormal or failure conditions.
- Avoid use of PPTC device in a constrained space such as potting material, housing and containers where have limited space to accommodate device thermal expansion and/or contraction.

FRX90V Series



Application

Telecom & wide variety of electronic equipment

Product Features

Low hold current, Solid state, Radial leaded product ideal for up to 90V_{DC}



Operation Current

0.10A~3.75A

Maximum Voltage

Up to 90V_{DC}



Temperature Range

-40°C to 85°C

Agency Recognition

AGENCY	AGENCY FILE NUMBER
	UL(E211981)
	C-UL(E211981)
	TÜV (R50004084)



Electrical Characteristics (23°C)

Part Number	Hold Current I _H , A	Trip Current I _T , A	Max. Time to trip at 5xI _H , s	Max. Current I _{MAX} , A	Rated Voltage V _{MAX} , V _{DC}	Typ. Power Pd, W	Resistance	
							R _{MIN} Ohms	R _{1MAX} Ohms
FRX010-90F	0.10	0.20	4.0	40	72/90	0.38	2.50	7.50
FRX015-90F	0.15	0.35	10.0	40	72/90	0.70	2.40	7.00
FRX017-90F	0.17	0.34	3.0	40	72/90	0.48	2.00	8.00
FRX020-90F	0.20	0.40	2.2	40	72/90	0.41	1.83	4.40
FRX025-90F	0.25	0.50	2.5	40	72/90	0.45	1.25	3.00
FRX030-90F	0.30	0.60	3.0	40	72/90	0.49	0.88	2.10
FRX035-90F	0.35	0.75	10.0	40	72/90	1.30	0.70	2.50
FRX040-90F	0.40	0.80	3.8	40	72/90	0.56	0.55	1.29
FRX050-90F	0.50	1.00	4.0	40	72/90	0.77	0.50	1.17
FRX055-90F	0.55	1.20	10.0	40	72/90	1.50	0.40	1.50
FRX065-90F	0.65	1.30	5.3	40	72/90	0.88	0.31	0.72
FRX075-90F	0.75	1.50	6.3	40	72/90	0.92	0.25	0.60
FRX090-90F	0.90	1.80	7.2	40	72/90	0.99	0.20	0.47
FRX110-90F	1.10	2.20	8.2	40	72/90	1.50	0.15	0.38
FRX135-90F	1.35	2.70	9.6	40	72/90	1.70	0.12	0.30
FRX160-90F	1.60	3.20	11.4	40	72/90	1.90	0.09	0.22
FRX185-90F	1.85	3.70	12.6	40	72/90	2.10	0.08	0.19
FRX250-90F	2.50	5.00	15.6	40	72/90	2.50	0.05	0.13
FRX300-90F	3.00	6.00	19.8	40	72/90	2.80	0.04	0.10
FRX375-90F	3.75	7.50	24.0	40	72/90	3.20	0.03	0.08

Thermal Derating for PPTC Device at Various Ambient Temperatures

TEMPERATURE	-40°C	-20°C	0°C	23°C	30°C	40°C	50°C	60°C	70°C	85°C
DERATING %	158%	138%	119%	100%	90%	81%	70%	60%	50%	36%

Typical Time-To-Trip at 23°C

- A = FRX010-90F K = FRX065-90F
- B = FRX015-90F L = FRX075-90F
- C = FRX017-90F M = FRX090-90F
- D = FRX020-90F N = FRX110-90F
- E = FRX025-90F O = FRX135-90F
- F = FRX030-90F P = FRX160-90F
- G = FRX035-90F Q = FRX185-90F
- H = FRX040-90F R = FRX250-90F
- I = FRX050-90F S = FRX300-90F
- J = FRX055-90F T = FRX375-90F

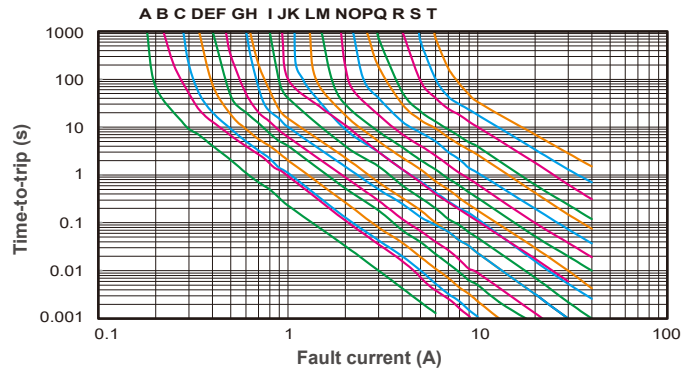

FRX90V Product Dimensions (mm)

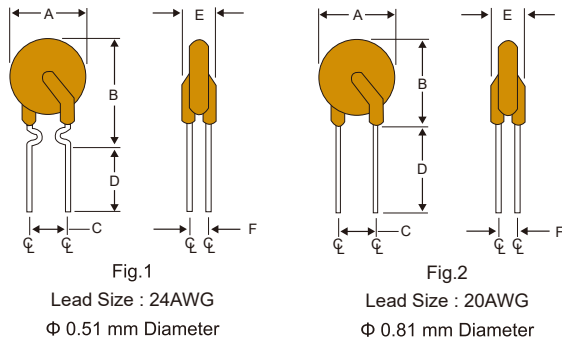

Part Number	Fig.	A	B	C	D	E	F
		Max.	Max.	Typ.	Min.	Max.	Typ.
FRX010-90F	1	7.4	12.7	5.1	7.6	3.1	1.1
FRX015-90F	1	7.4	12.7	5.1	7.6	3.1	1.1
FRX017-90F	1	7.4	12.7	5.1	7.6	3.1	1.1
FRX020-90F	1	7.4	12.7	5.1	7.6	3.1	1.1
FRX025-90F	1	7.4	12.7	5.1	7.6	3.1	1.1
FRX030-90F	1	7.4	12.7	5.1	7.6	3.1	1.1
FRX035-90F	1	7.4	12.7	5.1	7.6	3.1	1.1
FRX040-90F	1	7.6	13.5	5.1	7.6	3.1	1.1
FRX050-90F	1	7.9	13.7	5.1	7.6	3.1	1.1
FRX055-90F	1	9.7	14.0	5.1	7.6	3.1	1.1
FRX065-90F	1	9.7	14.5	5.1	7.6	3.1	1.1
FRX075-90F	1	10.4	15.2	5.1	7.6	3.1	1.1
FRX090-90F	1	11.7	15.8	5.1	7.6	3.1	1.1
FRX110-90F	2	13.0	18.0	5.1	7.6	3.1	1.4
FRX135-90F	2	14.5	19.6	5.1	7.6	3.1	1.4
FRX160-90F	2	16.3	21.3	5.1	7.6	3.1	1.4
FRX185-90F	2	17.8	22.9	5.1	7.6	3.1	1.4
FRX250-90F	2	21.3	26.4	10.2	7.6	3.1	1.4
FRX300-90F	2	24.9	30.0	10.2	7.6	3.1	1.4
FRX375-90F	2	28.5	33.5	10.2	7.6	3.1	1.4

Part Numbering System

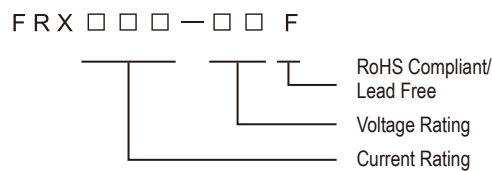

Part Marking System

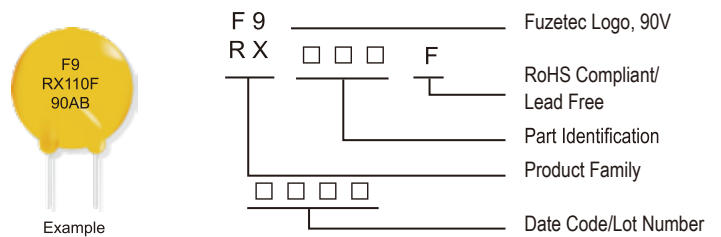

Package Information

Part Number	Standard Package
FRX010-90F~FRX055-90F	: 500Pcs/Bag, 3.0K Reel/Tape
FRX065-90F~FRX090-90F	: 300Pcs/Bag, 3.0K Reel/Tape
FRX110-90F	: 300Pcs/Bag, 1.5K Reel/Tape
FRX135-90F~FRX185-90F	: 200Pcs/Bag, 1.5K Reel/Tape
FRX250-90F~FRX375-90F	: 100Pcs/Bag, 1.0K Reel/Tape

Physical specifications

Lead material	FRX010-90F~FRX040-90F Tin plated copper clad steel, 24 AWG.
	FRX050-90F~FRX090-90F Tin plated copper, 24 AWG.
	FRX110-90F~FRX375-90F Tin plated copper, 20 AWG.
Soldering characteristics	MIL-STD-202, Method 208E.
Insulating coating	Flame retardant epoxy, meets UL-94V-0 requirement.

Warning :



- Each product should be carefully evaluated and tested for their suitability of application.
- Operation beyond the specified maximum ratings or improper use may result in damage and possible electrical arcing and/or flame.
- PPTC device are intended for occasional overcurrent protection. Application for repeated overcurrent condition and/or prolonged trip are not anticipated.
- Avoid contact of PPTC device with chemical solvent, including some inert material such as silicone based oil, lubricant and etc. Prolonged contact will damage the device performance.
- Additional protection mechanism are strongly recommended to be used in conjunction with the PPTC device for protection against abnormal or failure conditions.
- Avoid use of PPTC device in a constrained space such as potting material, housing and containers where have limited space to accommodate device thermal expansion and/or contraction.

FRU Series

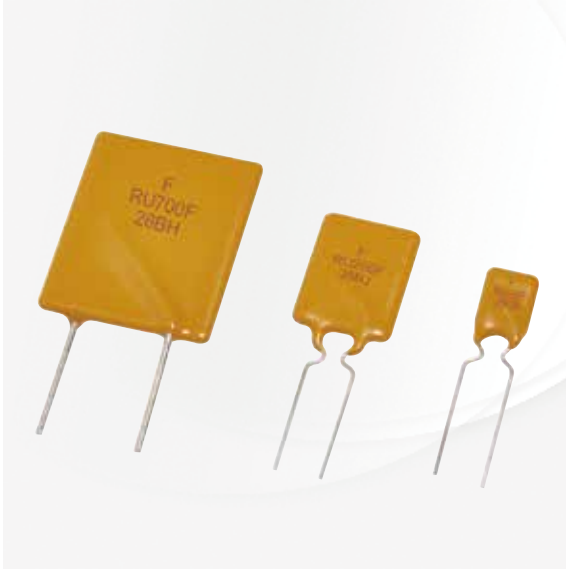

Application

Wide variety of electronic equipment

Product Features

Low resistance, High hold current, Solid state
Radial-leaded product ideal for up to 30V_{DC}



Operation Current

0.90A~9.00A

Maximum Voltage

30V_{DC}



Temperature Range

-40°C to 85°C

Agency Recognition

AGENCY	AGENCY FILE NUMBER
	UL(E211981)
	C-UL(E211981)
	TÜV (R50004084)



Electrical Characteristics (23°C)

Part Number	Hold Current I _H , A	Trip Current I _T , A	Max. Time to trip at 5xI _H , s	Max. Current I _{MAX} , A	Rated Voltage V _{MAX} , V _{DC}	Typ. Power Pd, W	Resistance	
							R _{MIN} Ohms	R _{1MAX} Ohms
FRU090-30F	0.90	1.80	5.9	100	30	0.6	0.070	0.220
FRU110-30F	1.10	2.20	6.6	100	30	0.7	0.050	0.170
FRU135-30F	1.35	2.70	7.3	100	30	0.8	0.040	0.130
FRU160-30F	1.60	3.20	8.0	100	30	0.9	0.030	0.110
FRU185-30F	1.85	3.70	8.7	100	30	1.0	0.030	0.090
FRU250-30F	2.50	5.00	10.3	100	30	1.2	0.020	0.070
FRU300-30F	3.00	6.00	10.8	100	30	2.0	0.020	0.080
FRU400-30F	4.00	8.00	12.7	100	30	2.5	0.010	0.050
FRU500-30F	5.00	10.00	14.5	100	30	3.0	0.010	0.050
FRU600-30F	6.00	12.00	16.0	100	30	3.5	0.005	0.040
FRU700-30F	7.00	14.00	17.5	100	30	3.8	0.005	0.030
FRU800-30F	8.00	16.00	18.8	100	30	4.0	0.005	0.020
FRU900-30F	9.00	18.00	20.0	100	30	4.2	0.005	0.020

Thermal Derating for PPTC Device at Various Ambient Temperatures

TEMPERATURE	-40°C	-20°C	0°C	23°C	30°C	40°C	50°C	60°C	70°C	85°C
DERATING %	145%	130%	115%	100%	92%	84%	76%	70%	61%	50%

Typical Time-To-Trip at 23°C

- A = FRU090-30F H = FRU400-30F
- B = FRU110-30F I = FRU500-30F
- C = FRU135-30F J = FRU600-30F
- D = FRU160-30F K = FRU700-30F
- E = FRU185-30F L = FRU800-30F
- F = FRU250-30F M = FRU900-30F
- G = FRU300-30F

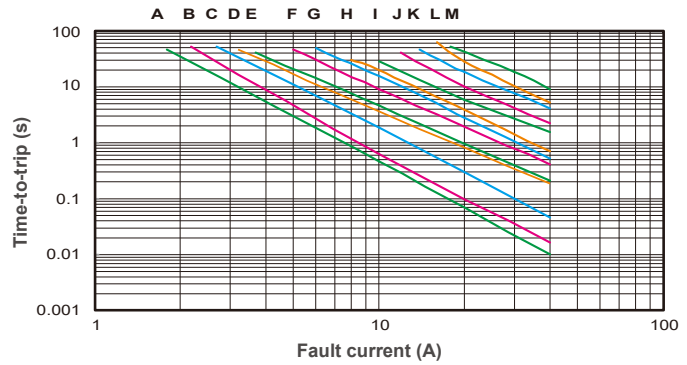

FRU Product Dimensions (mm)

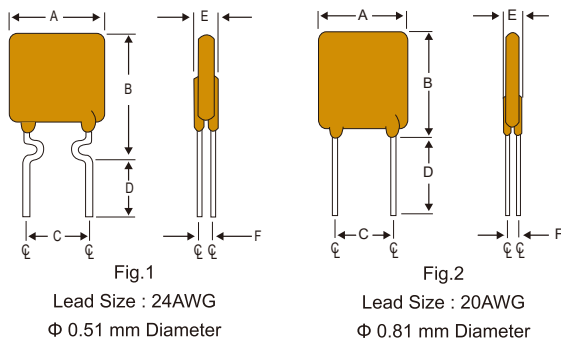

Part Number	Fig.	A	B	C	D	E	F
		Max.	Max.	Typ.	Min.	Max.	Typ.
FRU090-30F	1	7.4	12.2	5.1	7.6	3.0	0.9
FRU110-30F	1	7.4	14.2	5.1	7.6	3.0	0.9
FRU135-30F	1	8.9	13.5	5.1	7.6	3.0	0.9
FRU160-30F	1	8.9	15.2	5.1	7.6	3.0	0.9
FRU185-30F	1	10.2	15.7	5.1	7.6	3.0	0.9
FRU250-30F	1	11.4	18.3	5.1	7.6	3.0	0.9
FRU300-30F	2	11.4	17.3	5.1	7.6	3.0	1.2
FRU400-30F	2	14.0	20.1	5.1	7.6	3.0	1.2
FRU500-30F	2	14.0	24.9	10.2	7.6	3.0	1.2
FRU600-30F	2	16.5	24.9	10.2	7.6	3.0	1.2
FRU700-30F	2	19.1	26.7	10.2	7.6	3.0	1.2
FRU800-30F	2	21.6	29.2	10.2	7.6	3.0	1.2
FRU900-30F	2	24.1	29.7	10.2	7.6	3.0	1.2

Part Numbering System

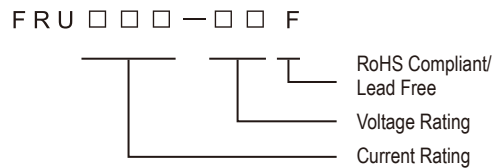

Part Marking System

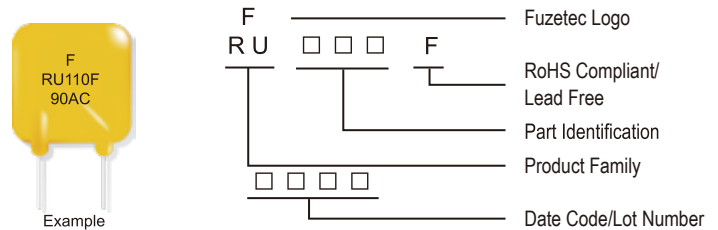

Package Information

Part Number	Standard Package
FRU090-30F~FRU110-30F	500 Pcs/Bag, 3.0K Reel/Tape
FRU135-30F~FRU250-30F	300 Pcs/Bag, 3.0K Reel/Tape
FRU300-30F~FRU400-30F	200 Pcs/Bag, 1.5K Reel/Tape
FRU500-30F	200 Pcs/Bag, 1.0K Reel/Tape
FRU600-30F~FRU900-30F	100 Pcs/Bag

Physical specifications

Lead material	FRU090-30F~FRU250-30F Tin plated copper clad steel, 24 AWG. FRU300-30F~FRU900-30F Tin plated copper, 20 AWG.
Soldering characteristics	MIL-STD-202, Method 208E.
Insulating coating	Flame retardant epoxy, meets UL-94V-0 requirement.

Warning :



- Each product should be carefully evaluated and tested for their suitability of application.
- Operation beyond the specified maximum ratings or improper use may result in damage and possible electrical arcing and/or flame.
- PPTC device are intended for occasional overcurrent protection. Application for repeated overcurrent condition and/or prolonged trip are not anticipated.
- Avoid contact of PPTC device with chemical solvent, including some inert material such as silicone based oil, lubricant and etc. Prolonged contact will damage the device performance.
- Additional protection mechanism are strongly recommended to be used in conjunction with the PPTC device for protection against abnormal or failure conditions.
- Avoid use of PPTC device in a constrained space such as potting material, housing and containers where have limited space to accommodate device thermal expansion and/or contraction.

FRT Series

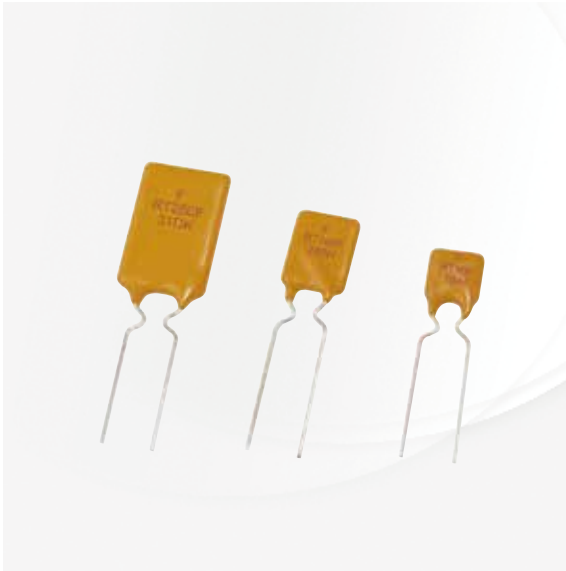

Application

IEEE 1394 Firewire, Computers & Consumer electronics

Product Features

Fast trip time, Lower Trip-to-hold Ratio, Radial-leaded product ideal for up to 36V_{DC}



Operation Current

0.50A~2.50A

Maximum Voltage

36V_{DC}



Temperature Range

-40°C to 85°C

Agency Recognition

AGENCY	AGENCY FILE NUMBER
	UL(E211981)
	C-UL(E211981)
	TÜV (R50004084)



Electrical Characteristics (23°C)

Part Number	Hold Current I _H , A	Trip Current I _T , A	Max. Time to trip at 5xI _H , S	Max. Current I _{MAX} , A	Rated Voltage V _{MAX} , V _{DC}	Typ. Power Pd, W	Resistance	
							R _{MIN} Ohms	R _{1MAX} Ohms
FRT050-33F	0.50	1.00	5.0	40	36	0.67	0.140	0.448
FRT075-33F	0.75	1.50	4.0	40	36	0.71	0.115	0.368
FRT090-33F	0.90	1.80	3.5	40	36	0.74	0.090	0.288
FRT120-33F	1.20	2.30	3.5	40	36	0.78	0.074	0.180
FRT135-33F	1.35	2.50	4.5	40	36	0.84	0.059	0.143
FRT160-33F	1.60	2.75	4.5	40	36	0.86	0.041	0.131
FRT190-33F	1.90	3.00	3.5	40	36	0.90	0.045	0.092
FRT220-33F	2.20	3.50	6.5	40	36	0.95	0.025	0.080
FRT250-33F	2.50	4.00	8.0	40	36	0.99	0.020	0.064

Thermal Derating for PPTC Device at Various Ambient Temperatures

TEMPERATURE	-40°C	-20°C	0°C	23°C	30°C	40°C	50°C	60°C	70°C	85°C
DERATING %	148%	134%	120%	100%	98%	90%	84%	78%	70%	59%

Typical Time-To-Trip at 23°C

- A = FRT050-33F
- B = FRT075-33F
- C = FRT090-33F
- D = FRT120-33F
- E = FRT135-33F
- F = FRT160-33F
- G = FRT190-33F
- H = FRT220-33F
- I = FRT250-33F

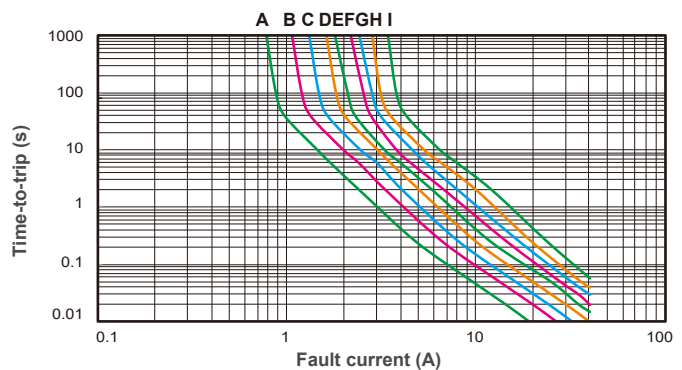

FRT Product Dimensions (mm)

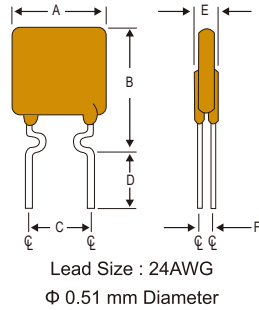

Part Number	A	B	C	D	E	F
	Max.	Max.	Typ.	Min.	Max.	Typ.
FRT050-33F	7.4	12.2	5.1	7.6	3.0	1.1
FRT075-33F	7.4	12.2	5.1	7.6	3.0	1.1
FRT090-33F	7.4	12.2	5.1	7.6	3.0	1.1
FRT120-33F	7.4	12.2	5.1	7.6	3.0	1.1
FRT135-33F	7.4	14.2	5.1	7.6	3.0	1.1
FRT160-33F	7.4	14.0	5.1	7.6	3.0	1.1
FRT190-33F	9.0	13.5	5.1	7.6	3.0	1.1
FRT220-33F	10.0	17.0	5.1	7.6	3.0	1.1
FRT250-33F	10.0	19.5	5.1	7.6	3.0	1.1

Part Numbering System

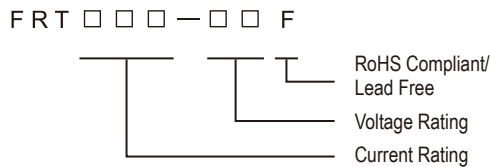

Part Marking System

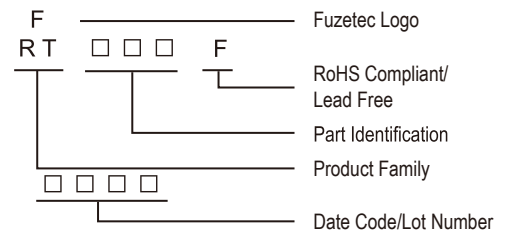

Package Information

Part Number	Standard Package
FRT050-33F~FRT250-33F	: 500Pcs/Bag, 3.0K Reel/Tape

Physical specifications

Lead material	Tin plated copper clad steel, 24 AWG.
Soldering characteristics	MIL-STD-202, Method 208E.
Insulating coating	Flame retardant epoxy, meets UL-94V-0 requirement.

Warning :



- Each product should be carefully evaluated and tested for their suitability of application.
- Operation beyond the specified maximum ratings or improper use may result in damage and possible electrical arcing and/or flame.
- PPTC device are intended for occasional overcurrent protection. Application for repeated overcurrent condition and/or prolonged trip are not anticipated.
- Avoid contact of PPTC device with chemical solvent, including some inert material such as silicone based oil, lubricant and etc. Prolonged contact will damage the device performance.
- Additional protection mechanism are strongly recommended to be used in conjunction with the PPTC device for protection against abnormal or failure conditions.
- Avoid use of PPTC device in a constrained space such as potting material, housing and containers where have limited space to accommodate device thermal expansion and/or contraction.

FUSB Series



Application

Low voltage USB equipment

Product Features

Low resistance, Fast trip time, Lower Trip-to-hold Ratio



Operation Current

0.75A ~2.50A

Maximum Voltage

16V/30V_{DC}



Temperature Range

-40°C to 85°C

Agency Recognition

AGENCY	AGENCY FILE NUMBER
	UL(E211981)
	C-UL(E211981)
	TÜV (R50004084)



Electrical Characteristics (23°C)

Part Number	Hold Current	Trip Current	Max. Time to trip		Max. Current	Rated Voltage	Typ. Power	Resistance	
			Current	Time				R _{MIN}	R _{1MAX}
			I _H , A	I _T , A				A	Sec
FUSB075F	0.75	1.30	8.0	0.4	40	16	0.3	0.08	0.23
FUSB090F	0.90	1.80	8.0	1.2	40	16/30	0.6	0.07	0.18
FUSB110F	1.10	2.20	8.0	2.3	40	16/30	0.7	0.05	0.14
FUSB120F	1.20	2.00	8.0	0.7	40	16	0.6	0.04	0.14
FUSB135F	1.35	2.70	8.0	4.5	40	16/30	0.8	0.04	0.12
FUSB155F	1.55	2.70	7.8	2.2	40	16	0.7	0.03	0.12
FUSB160F	1.60	3.20	8.0	9.0	40	16/30	0.9	0.03	0.11
FUSB185F	1.85	3.70	8.0	10.0	40	16/30	1.0	0.03	0.09
FUSB250F	2.50	5.00	8.0	40.0	40	16/30	1.2	0.02	0.07

Thermal Derating for PPTC Device at Various Ambient Temperatures

TEMPERATURE	-40°C	-20°C	0°C	23°C	30°C	40°C	50°C	60°C	70°C	85°C
DERATING %	145%	130%	115%	100%	91%	83%	78%	70%	61%	50%

Typical Time-To-Trip at 23°C

- A = FUSB075F
- B = FUSB120F
- C = FUSB155F

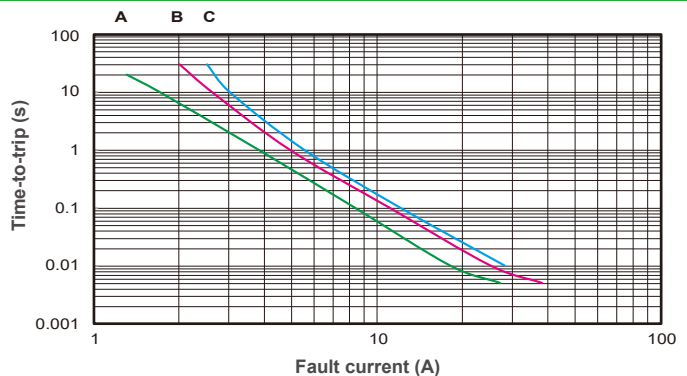

Typical Time-To-Trip at 23°C

- D = FUSB090F
- E = FUSB110F
- F = FUSB135F
- G = FUSB160F
- H = FUSB185F
- I = FUSB250F

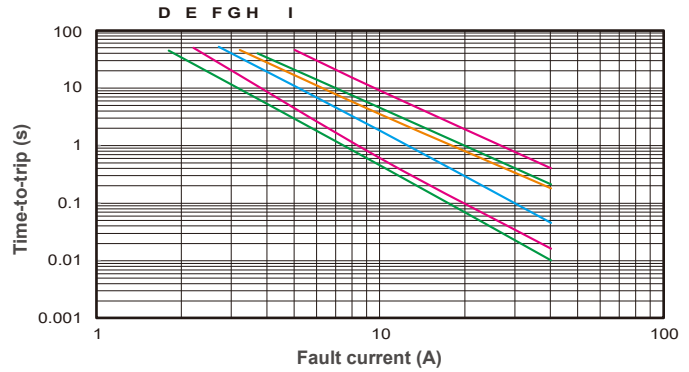

FUSB Product Dimensions (mm)

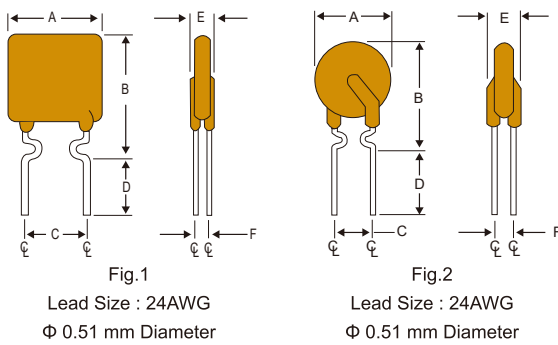

Part Number	Fig.	A	B	C	D	E	F
		Max.	Max.	Typ.	Min.	Max.	Typ.
FUSB075F	2	6.9	11.4	5.1	7.6	3.0	0.8
FUSB090F	1	7.4	12.2	5.1	7.6	3.0	0.8
FUSB110F	1	7.4	14.2	5.1	7.6	3.0	0.8
FUSB120F	2	6.9	11.7	5.1	7.6	3.0	0.8
FUSB135F	1	8.9	13.5	5.1	7.6	3.0	0.8
FUSB155F	2	6.9	11.7	5.1	7.6	3.0	0.8
FUSB160F	1	8.9	15.2	5.1	7.6	3.0	0.8
FUSB185F	1	10.2	15.7	5.1	7.6	3.0	0.8
FUSB250F	1	11.4	18.3	5.1	7.6	3.0	0.8

Part Numbering System

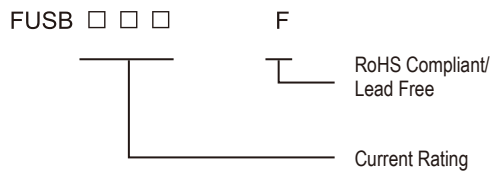

Part Marking System

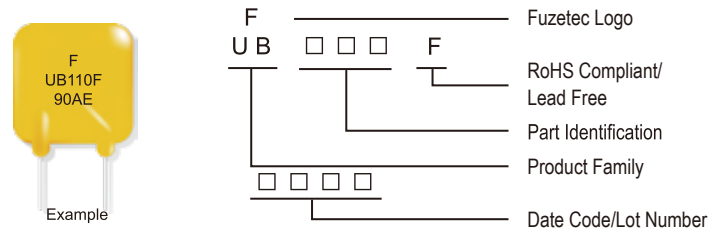

Package Information

Part Number	Standard Package
FUSB075F~FUSB250F	: 500Pcs/Bag, 3.0K Reel/Tape

Physical specifications

Lead material	Tin plated copper clad steel, 24 AWG.
Soldering characteristics	MIL-STD-202, Method 208E.
Insulating coating	Flame retardant epoxy polymer, meets UL-94V-0 requirement.

Warning :



- Each product should be carefully evaluated and tested for their suitability of application.
- Operation beyond the specified maximum ratings or improper use may result in damage and possible electrical arcing and/or flame.
- PPTC device are intended for occasional overcurrent protection. Application for repeated overcurrent condition and/or prolonged trip are not anticipated.
- Avoid contact of PPTC device with chemical solvent, including some inert material such as silicone based oil, lubricant and etc. Prolonged contact will damage the device performance.
- Additional protection mechanism are strongly recommended to be used in conjunction with the PPTC device for protection against abnormal or failure conditions.
- Avoid use of PPTC device in a constrained space such as potting material, housing and containers where have limited space to accommodate device thermal expansion and/or contraction.

FRG Series



Application

Wide variety of electronic equipment

Product Features

Very high hold current, Solid state Radial-leaded product ideal for up to 16V_{DC}



Operation Current

2.50 A~14.00A

Maximum Voltage

16V_{DC}



Temperature Range

-40°C to 85°C

Agency Recognition

AGENCY	AGENCY FILE NUMBER
	UL(E211981)
	C-UL(E211981)
	TÜV (R50004084)



Electrical Characteristics (23°C)

Part Number	Hold Current I _H , A	Trip Current I _T , A	Max. Time to trip at 5xI _H , s	Max. Current I _{MAX} , A	Rated Voltage V _{MAX} , V _{DC}	Typ. Power Pd, W	Resistance	
							R _{MIN} Ohms	R1 _{MAX} Ohms
FRG250-16F	2.5	4.7	5.0	100	16	1.0	0.022	0.053
FRG300-16F	3.0	5.1	2.0	100	16	2.3	0.034	0.105
FRG400-16F	4.0	6.8	3.5	100	16	2.4	0.020	0.063
FRG500-16F	5.0	8.5	3.6	100	16	2.6	0.014	0.044
FRG600-16F	6.0	10.2	5.8	100	16	2.8	0.009	0.033
FRG700-16F	7.0	11.9	8.0	100	16	3.0	0.006	0.021
FRG800-16F	8.0	13.6	9.0	100	16	3.0	0.005	0.018
FRG900-16F	9.0	15.3	12.0	100	16	3.3	0.004	0.015
FRG1000-16F	10.0	17.0	12.5	100	16	3.3	0.003	0.012
FRG1100-16F	11.0	18.7	13.5	100	16	3.7	0.003	0.010
FRG1200-16F	12.0	20.4	16.0	100	16	4.2	0.002	0.009
FRG1400-16F	14.0	23.8	20.0	100	16	4.6	0.002	0.008

Thermal Derating for PPTC Device at Various Ambient Temperatures

TEMPERATURE	-40°C	-20°C	0°C	23°C	30°C	40°C	50°C	60°C	70°C	85°C
DERATING %	148%	132%	116%	100%	91%	84%	76%	69%	60%	48%

Typical Time-To-Trip at 23°C

- A = FRG250-16F G = FRG800-16F
- B = FRG300-16F H = FRG900-16F
- C = FRG400-16F I = FRG1000-16F
- D = FRG500-16F J = FRG1100-16F
- E = FRG600-16F K = FRG1200-16F
- F = FRG700-16F L = FRG1400-16F

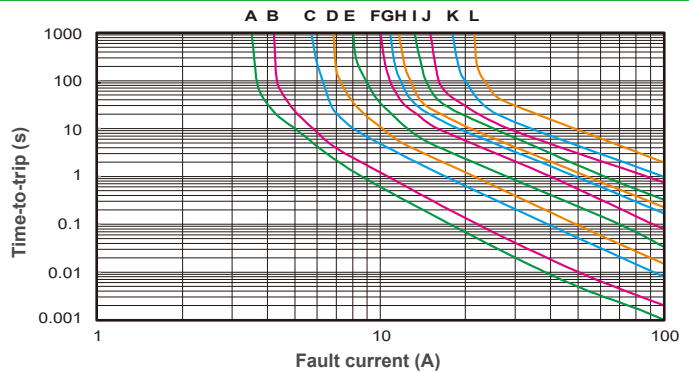

FRG Product Dimensions (mm)

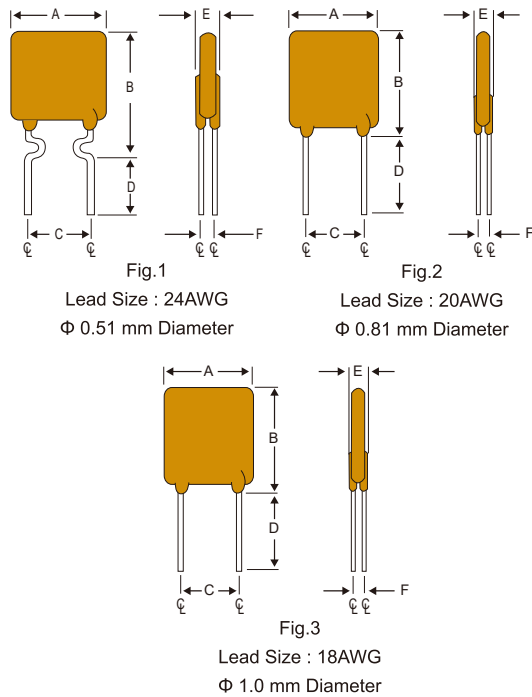

Part Number	Fig.	A	B	C	D	E	F
		Max.	Max.	Typ.	Min.	Max.	Typ.
FRG250-16F	1	8.9	12.8	5.1	7.6	3.0	1.2
FRG300-16F	2	7.1	11.0	5.1	7.6	3.0	1.2
FRG400-16F	2	8.9	12.8	5.1	7.6	3.0	1.2
FRG500-16F	2	10.4	14.3	5.1	7.6	3.0	1.2
FRG600-16F	2	10.7	17.1	5.1	7.6	3.0	1.2
FRG700-16F	2	11.2	19.7	5.1	7.6	3.0	1.2
FRG800-16F	2	12.7	20.9	5.1	7.6	3.0	1.2
FRG900-16F	2	14.0	21.7	5.1	7.6	3.0	1.2
FRG1000-16F	2	16.5	24.1	5.1	7.6	3.0	1.2
FRG1100-16F	2	17.5	26.0	5.1	7.6	3.0	1.2
FRG1200-16F	3	17.5	28.0	10.2	7.6	3.6	1.4
FRG1400-16F	3	27.9	27.9	10.2	7.6	3.6	1.4

Part Numbering System

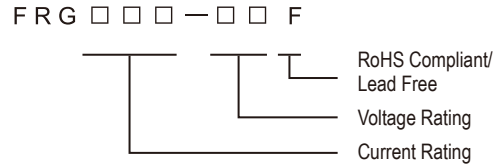

Part Marking System

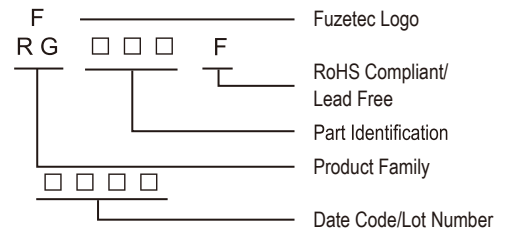

Package Information

Part Number	Standard Package
FRG250-16F~FRG300-16F	: 500 Pcs/Bag, 2.5K Reel/Tape
FRG400-16F~FRG600-16F	: 300 Pcs/Bag, 2.5K Reel/Tape
FRG700-16F	: 200 Pcs/Bag, 1.5K Reel/Tape
FRG800-16F~FRG900-16F	: 200 Pcs/Bag
FRG1000-16F~FRG1400-16F	: 100 Pcs/Bag

Physical specifications

Lead material	FRG250-16F Tin plated copper clad steel, 24 AWG.
	FRG300-16F~FRG1100-16F Tin plated copper, 20 AWG.
	FRG1200-16F~FRG1400-16F Tin plated copper, 18 AWG.
Soldering characteristics	MIL-STD-202, Method 208E.
Insulating coating	Flame retardant epoxy, meets UL-94V-0 requirement.

Warning :



- Each product should be carefully evaluated and tested for their suitability of application.
- Operation beyond the specified maximum ratings or improper use may result in damage and possible electrical arcing and/or flame.
- PPTC device are intended for occasional overcurrent protection. Application for repeated overcurrent condition and/or prolonged trip are not anticipated.
- Avoid contact of PPTC device with chemical solvent, including some inert material such as silicone based oil, lubricant and etc. Prolonged contact will damage the device performance.
- Additional protection mechanism are strongly recommended to be used in conjunction with the PPTC device for protection against abnormal or failure conditions.
- Avoid use of PPTC device in a constrained space such as potting material, housing and containers where have limited space to accommodate device thermal expansion and/or contraction.

FRHV Series



Application

Telecommunication and Data transmitting

Product Features

Low hold current, Solid state



Operation Current

0.08 A~0.40A

Maximum Operating Voltage

60V/100V/250V_{DC}

Maximum Interrupt Voltage

250V/600V_{AC}



Temperature Range

-40°C to 85°C

Agency Recognition

AGENCY	AGENCY FILE NUMBER
	UL(E211981)
	C-UL(E211981)
	TÜV (R50138901)



SVHC Compliant

Electrical Characteristics (23°C)

Part Number	Hold Current	Trip Current	Max. Time to trip		Max. Current	Max. Oper. Voltage	Max. Int. Voltage	Typ. Power	Resistance	
			Current	Time					R _{MIN}	R _{1MAX}
FRH080-250VF	0.08	0.16	0.35	4.0	3.0	100	250	1.0	14.00	33.00
FRH110-250VF	0.11	0.22	1.00	2.0	3.0	100	250	1.0	5.00	16.00
FRH120-250VF	0.12	0.24	1.00	2.0	3.0	100	250	1.0	4.00	16.00
FRH145-250VF	0.15	0.29	1.00	2.5	3.0	100	250	1.0	3.00	12.00
FRH180-250XF	0.18	0.65	3.00	2.0	10.0	100	250	1.0	0.80	4.00
FRH150-600MF	0.15	0.30	1.00	4.0	3.0	250	600	1.0	6.00	17.00
FRH160-600MF	0.16	0.32	1.00	7.0	3.0	250	600	1.0	4.00	16.00
FRH160-600VF	0.16	0.32	1.00	7.0	3.0	250	600	1.0	4.00	18.00
FRH200-600VF	0.20	0.40	1.00	12.0	3.0	250	600	1.0	4.00	13.50
FRH250-600VF	0.25	0.85	3.00	1.0	3.0	250	600	1.0	1.00	7.00
FRH400-600F	0.40	1.00	3.00	4.0	3.0	60	600	1.0	0.95	1.90

Thermal Derating for PPTC Device at Various Ambient Temperatures

TEMPERATURE	-40°C	-20°C	0°C	23°C	30°C	40°C	50°C	60°C	70°C	85°C
DERATING %	158%	138%	119%	100%	92%	83%	73%	64%	54%	40%

Typical Time-To-Trip at 23°C

- A = FRH080-250VF
- B = FRH110-250VF
- C = FRH120-250VF
- D = FRH145-250VF
- E = FRH180-250XF

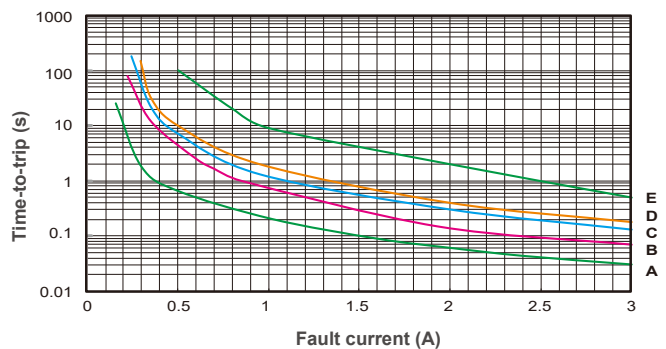

Typical Time-To-Trip at 23°C

- F = FRH150-600MF
- G = FRH160-600MF
- H = FRH160-600VF
- I = FRH200-600VF
- J = FRH250-600VF
- K = FRH400-600F

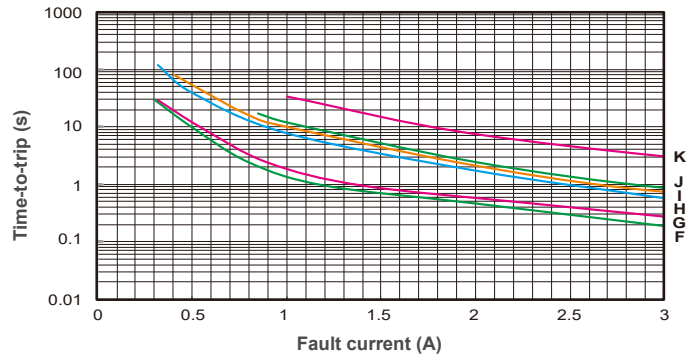

FRHV Product Dimensions (mm)

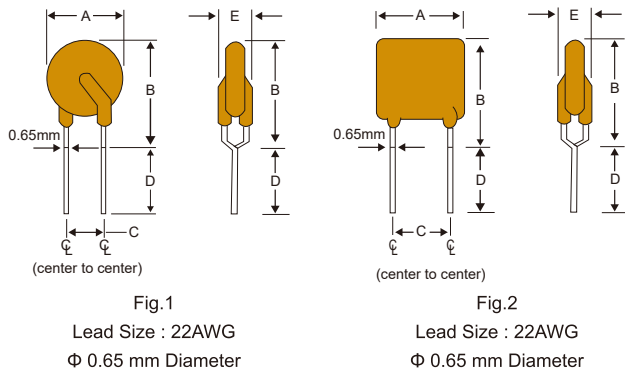

Part Number	Fig.	A	B	C	D	E
		Max.	Max.	Typ.	Min.	Max.
FRH080-250VF	1	5.8	9.6	5.0	4.7	4.6
FRH110-250VF	1	6.8	9.9	5.0	4.7	4.6
FRH120-250VF	2	6.5	11.0	5.0	4.7	4.6
FRH145-250VF	2	6.5	11.0	5.0	4.7	4.6
FRH180-250XF	1	9.0	12.0	5.0	4.7	3.8
FRH150-600MF	2	9.0	12.5	5.0	4.7	4.6
FRH160-600MF	2	9.0	12.5	5.0	4.7	4.6
FRH160-600VF	2	16.0	12.6	5.0	4.7	6.0
FRH200-600VF	2	12.0	14.0	5.0	4.7	6.0
FRH250-600VF	2	12.0	15.0	5.0	4.7	6.0
FRH400-600F	2	15.0	18.0	5.0	4.7	6.0

Part Numbering System

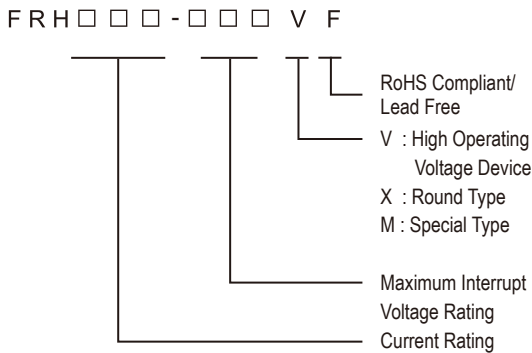

Part Marking System

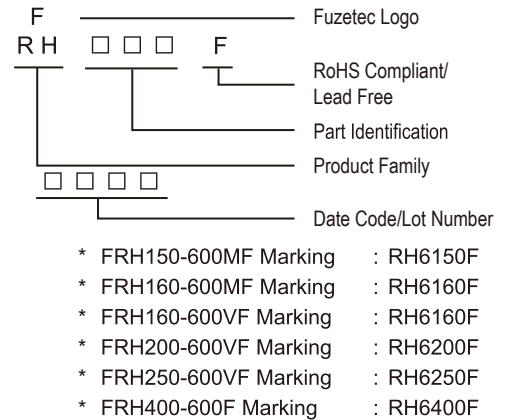

Package Information

Part Number	Standard Package
FRH080-250VF~FRH145-250VF	300 Pcs/Bag, 1.5K Reel/Tape
FRH180-250XF	200 Pcs/Bag, 1.5K Reel/Tape
FRH150-600MF~FRH160-600MF	100 Pcs/Bag, 1.2K Reel/Tape
FRH160-600VF	100 Pcs/Bag, 0.6K Reel/Tape
FRH200-600VF~FRH400-600F	100 Pcs/Bag

Physical specifications

Lead material	Tin plated copper, 22 AWG.
Soldering characteristics	MIL-STD-202, Method 208E.
Insulating coating	Flame retardant epoxy, meets UL-94V-0 requirement.
*NOTE : All FRHV products are designed to assist equipment to pass ITU K20/K21 UL60950 or GR1089 specification.	
*FRH150-600MF, FRH160-600VF meet UL497A Overvoltage and Endurance Conditioning requirements for Thermistor type component.	

Warning :



- Each product should be carefully evaluated and tested for their suitability of application.
- Operation beyond the specified maximum ratings or improper use may result in damage and possible electrical arcing and/or flame.
- PPTC device are intended for occasional overcurrent protection. Application for repeated overcurrent condition and/or prolonged trip are not anticipated.
- Avoid contact of PPTC device with chemical solvent, including some inert material such as silicone based oil, lubricant and etc. Prolonged contact will damage the device performance.
- Additional protection mechanism are strongly recommended to be used in conjunction with the PPTC device for protection against abnormal or failure conditions.
- Avoid use of PPTC device in a constrained space such as potting material, housing and containers where have limited space to accommodate device thermal expansion and/or contraction.

NOTE : All Specifications subject to change without notice.

FRV Series



Application

Line Voltage Power Supply, Transformer and Appliances

Product Features

Low hold current, Solid state, Radial leaded product ideal for up to 265V_{AC/DC}



Maximum Operation Current

0.05A~2.00A

Maximum Operating Voltage

240V_{AC/DC}

Maximum Interrupt Voltage

265V_{AC/DC}



Temperature Range

-40°C to 85°C

Agency Recognition

AGENCY	AGENCY FILE NUMBER
	UL(E211981)
	C-UL(E211981)
	TÜV (R50087018)



Electrical Characteristics (23°C)

Part Number	Hold Current I _H , A	Trip Current I _T , A	Max. Time to trip at 5xI _H , S	Max. Current I _{MAX} , A	Rated Voltage V _{MAX} , V _{AC/DC}	Max. Int. Voltage V _{I-MAX} , V _{AC/DC}	Typ. Power Pd, W	Resistance	
								R _{MIN} Ohms	R _{1MAX} Ohms
FRV005-240F	0.05	0.12	15.0	1.0	240	265	0.70	18.50	65.00
FRV008-240F	0.08	0.19	15.0	1.2	240	265	0.80	7.40	26.00
FRV012-240F	0.12	0.30	15.0	1.2	240	265	1.00	3.00	12.00
FRV016-240F	0.16	0.37	15.0	2.0	240	265	1.40	2.50	7.80
FRV025-240F	0.25	0.56	18.5	3.5	240	265	1.50	1.30	3.80
FRV033-240F	0.33	0.74	21.0	4.5	240	265	1.70	0.83	2.60
FRV040-240F	0.40	0.90	24.0	5.5	240	265	2.00	0.60	1.90
FRV055-240F	0.55	1.25	26.0	7.0	240	265	3.40	0.45	1.45
FRV075-240F	0.75	1.50	18.0	7.5	240	265	2.60	0.32	0.84
FRV100-240F	1.00	2.00	21.0	10.0	240	265	2.90	0.22	0.58
FRV125-240F	1.25	2.50	23.0	12.5	240	265	3.30	0.17	0.44
FRV150-240F	1.50	3.00	23.0	15.0	240	265	3.70	0.12	0.32
FRV200-240F	2.00	4.00	28.0	20.0	240	265	4.50	0.09	0.22

Thermal Derating for PPTC Device at Various Ambient Temperatures

TEMPERATURE	-40°C	-20°C	0°C	23°C	30°C	40°C	50°C	60°C	70°C	85°C
DERATING %	150%	134%	116%	100%	90%	81%	74%	65%	58%	44%

Typical Time-To-Trip at 23°C

- A = FRV005-240F H = FRV055-240F
- B = FRV008-240F I = FRV075-240F
- C = FRV012-240F J = FRV100-240F
- D = FRV016-240F K = FRV125-240F
- E = FRV025-240F L = FRV150-240F
- F = FRV033-240F M = FRV200-240F
- G = FRV040-240F

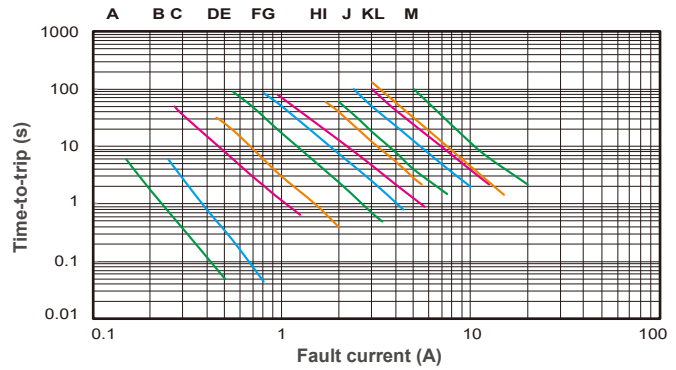

FRV Product Dimensions (mm)

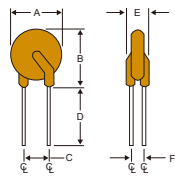

Fig.1

Lead Size : 24AWG
Φ 0.51 mm Diameter

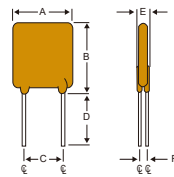

Fig.2

Lead Size : 22AWG
Φ 0.65 mm Diameter

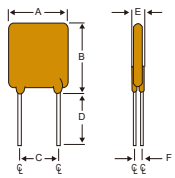

Fig.3

Lead Size : 20AWG
Φ 0.81 mm Diameter

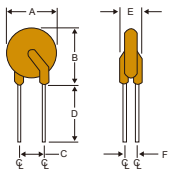
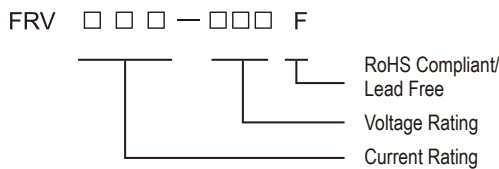

Fig.4

Lead Size : 20AWG
Φ 0.81 mm Diameter

Part Number	Fig	A	B	C	D	E	F
		Max.	Max.	Typ.	Min.	Max.	Typ.
FRV005-240F	1	8.3	10.7	5.1	7.6	3.8	1.6
FRV008-240F	1	8.3	10.7	5.1	7.6	3.8	1.6
FRV012-240F	1	8.3	10.7	5.1	7.6	3.8	1.6
FRV016-240F	1	9.9	12.5	5.1	7.6	3.8	1.6
FRV025-240F	2	9.6	17.4	5.1	7.6	3.8	1.8
FRV033-240F	2	11.4	16.5	5.1	7.6	3.8	1.8
FRV040-240F	2	11.5	19.5	5.1	7.6	3.8	1.8
FRV055-240F	3	14.0	21.7	5.1	7.6	4.1	1.9
FRV075-240F	3	11.5	23.4	5.1	7.6	4.8	1.9
FRV100-240F	4	18.7	24.4	10.2	7.6	5.1	1.9
FRV125-240F	4	21.2	27.4	10.2	7.6	5.3	1.9
FRV150-240F	4	23.4	30.9	10.2	7.6	5.3	1.9
FRV200-240F	3	24.9	33.8	10.2	7.6	6.1	1.9

Part Numbering System



Part Marking System

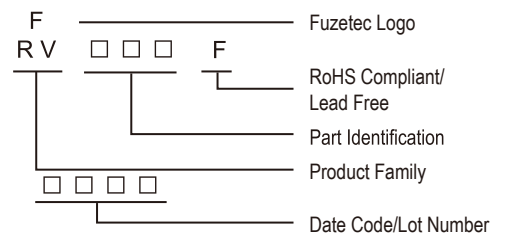

Package Information

Part Number	Standard Package
FRV005-240F~FRV016-240F	500 Pcs/Bag, 2.0K Reel/Tape
FRV025-240F	300 Pcs/Bag, 2.0K Reel/Tape
FRV033-240F~FRV040-240F	200 Pcs/Bag, 2.0K Reel/Tape
FRV055-240F	200 Pcs/Bag, 1.0K Reel/Tape
FRV075-240F	200 Pcs/Bag, 2.0K Reel/Tape
FRV100-240F~FRV200-240F	100 Pcs/Bag

Physical specifications

Lead material	FRV005-240F~FRV016-240F Tin plated copper clad steel, 24AWG.
	FRV025-240F~FRV040-240F Tin plated copper, 22AWG.
	FRV055-240F~FRV200-240F Tin plated copper, 20AWG.
Soldering characteristics	MIL-STD-202, Method 208E.
Insulating coating	Flame retardant epoxy, meets UL-94V-0 requirement.

Warning :



- Each product should be carefully evaluated and tested for their suitability of application.
- Operation beyond the specified maximum ratings or improper use may result in damage and possible electrical arcing and/or flame.
- PPTC device are intended for occasional overcurrent protection. Application for repeated overcurrent condition and/or prolonged trip are not anticipated.
- Avoid contact of PPTC device with chemical solvent, including some inert material such as silicone based oil, lubricant and etc. Prolonged contact will damage the device performance.
- Additional protection mechanism are strongly recommended to be used in conjunction with the PPTC device for protection against abnormal or failure conditions.
- Avoid use of PPTC device in a constrained space such as potting material, housing and containers where have limited space to accommodate device thermal expansion and/or contraction.

FRV 277V Series



Application

Line Voltage Power Supply, Transformer and Appliances

Product Features

Low hold current, Solid state, Radial leaded product ideal for up to 305V_{AC/DC}



Operation Current

0.05A~2.00A

Maximum Operating Voltage

277V_{AC/DC}

Maximum Interrupt Voltage

305V_{AC/DC}



Temperature Range

-20°C to 85°C

Agency Recognition



SVHC Compliant

AGENCY	AGENCY FILE NUMBER
	UL(FRV005-277F & FRV040-277F~FRV200-277F)
	C-UL(FRV005-277F & FRV040-277F~FRV200-277F)
	TÜV (In Process)

Electrical Characteristics (23°C)

Part Number	Hold Current I _H , A	Trip Current I _T , A	Max. Time to trip at 5xI _H , S	Max. Current I _{MAX} , A	Rated Voltage V _{MAX} , V _{AC/DC}	Max. Int. Voltage V _{I-MAX} , V _{AC/DC}	Typ. Power Pd, W	Resistance	
								R _{MIN} Ohms	R _{1MAX} Ohms
FRV005-277F	0.05	0.20	18.0	1.0	277	305	0.70	8.00	26.00
FRV008-277F	0.08	0.26	18.0	1.2	277	305	0.80	4.50	18.00
FRV012-277F	0.12	0.30	18.0	1.2	277	305	1.00	3.00	12.00
FRV016-277F	0.16	0.37	18.0	1.6	277	305	1.40	2.30	8.00
FRV025-277F	0.25	0.56	18.5	2.5	277	305	1.50	1.30	4.30
FRV033-277F	0.33	0.74	21.0	3.3	277	305	1.70	0.94	3.10
FRV040-277F	0.40	0.90	24.0	4.0	277	305	2.00	0.81	2.70
FRV055-277F	0.55	1.25	26.0	5.5	277	305	2.40	0.63	2.10
FRV075-277F	0.75	1.50	18.0	7.5	277	305	2.60	0.43	1.40
FRV100-277F	1.00	2.00	21.0	10.0	277	305	2.90	0.32	1.10
FRV125-277F	1.25	2.50	23.0	12.5	277	305	3.30	0.24	0.80
FRV150-277F	1.50	3.00	23.0	15.0	277	305	3.70	0.14	0.48
FRV200-277F	2.00	4.00	28.0	20.0	277	305	4.50	0.09	0.29

Thermal Derating for PPTC Device at Various Ambient Temperatures

TEMPERATURE	-20°C	0°C	20°C	30°C	40°C	50°C	60°C	70°C	85°C
DERATING %	150%	125%	100%	90%	81%	70%	55%	48%	30%

Typical Time-To-Trip at 23°C

- A = FRV005-277F H = FRV055-277F
- B = FRV008-277F I = FRV075-277F
- C = FRV012-277F J = FRV100-277F
- D = FRV016-277F K = FRV125-277F
- E = FRV025-277F L = FRV150-277F
- F = FRV033-277F M = FRV200-277F
- G = FRV040-277F

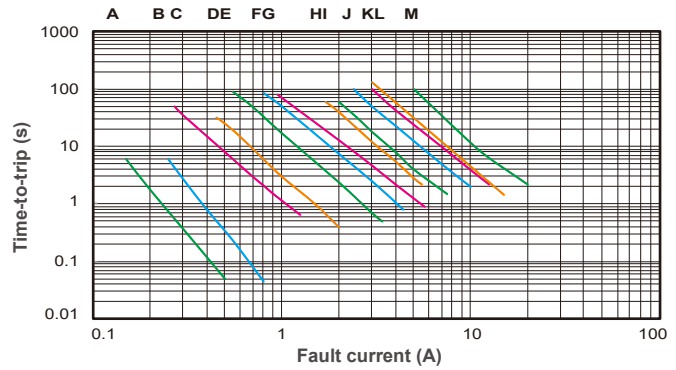

FRV Product Dimensions (mm)

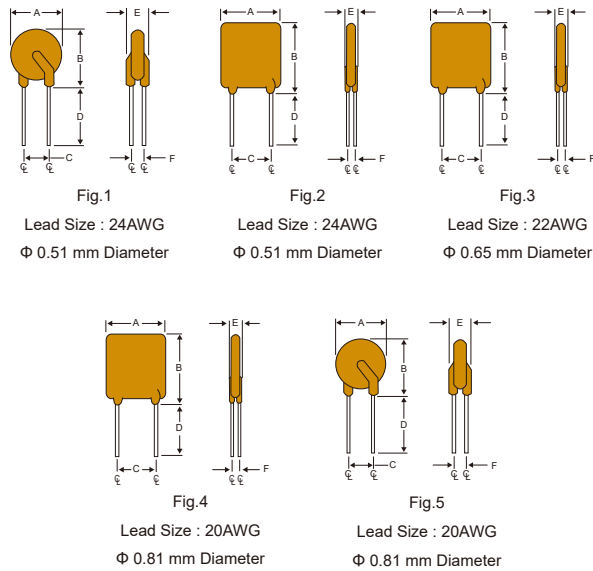

Part Number	Fig	A	B	C	D	E	F
		Max.	Max.	Typ.	Min.	Max.	Typ.
FRV005-277F	1	7.4	12.7	5.1	7.6	3.8	1.6
FRV008-277F	2	7.4	12.2	5.1	7.6	3.8	1.6
FRV012-277F	2	8.1	12.8	5.1	7.6	3.8	1.6
FRV016-277F	2	7.4	14.2	5.1	7.6	3.8	1.6
FRV025-277F	3	8.9	15.2	5.1	7.6	3.8	1.8
FRV033-277F	3	12.6	15.5	5.1	7.6	3.8	1.8
FRV040-277F	3	12.6	15.5	5.1	7.6	3.8	1.8
FRV055-277F	4	12.6	16.5	5.1	7.6	4.1	1.9
FRV075-277F	4	15.8	20.0	5.1	7.6	4.8	1.9
FRV100-277F	4	16.3	21.7	10.2	7.6	5.1	1.9
FRV125-277F	5	18.8	24.5	10.2	7.6	5.3	1.9
FRV150-277F	5	23.8	28.3	10.2	7.6	5.3	1.9
FRV200-277F	4	25.2	30.6	10.2	7.6	6.1	1.9

Part Numbering System

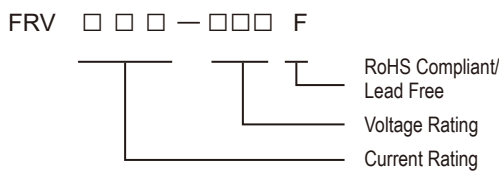

Part Marking System

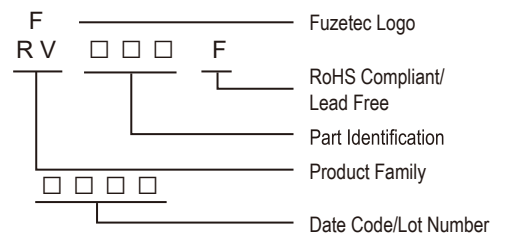

Physical specifications

Lead material	FRV005-277F~FRV016-277F Tin plated copper, 24AWG.
	FRV025-277F~FRV040-277F Tin plated copper, 22AWG.
	FRV055-277F~FRV200-277F Tin plated copper, 20AWG.
Soldering characteristics	MIL-STD-202, Method 208E.
Insulating coating	Flame retardant epoxy, meets UL-94V-0 requirement.

Warning :



- Each product should be carefully evaluated and tested for their suitability of application.
- Operation beyond the specified maximum ratings or improper use may result in damage and possible electrical arcing and/or flame.
- PPTC device are intended for occasional overcurrent protection. Application for repeated overcurrent condition and/or prolonged trip are not anticipated.
- Avoid contact of PPTC device with chemical solvent, including some inert material such as silicone based oil, lubricant and etc. Prolonged contact will damage the device performance.
- Additional protection mechanism are strongly recommended to be used in conjunction with the PPTC device for protection against abnormal or failure conditions.
- Avoid use of PPTC device in a constrained space such as potting material, housing and containers where have limited space to accommodate device thermal expansion and/or contraction.

FRVL Series



Application

Line Voltage Power Supply, Transformer and Appliances Product

Features

Solid state, Radial leaded product ideal for up to 120V_{AC/DC}



Maximum Operation Current

0.10A~3.75A

Maximum Voltage

120V_{AC/DC}

Maximum Interrupt Voltage

135V_{AC/DC}



Temperature Range

-40°C to 85°C

Agency Recognition

AGENCY	AGENCY FILE NUMBER
	UL(E211981)
	C-UL(E211981)
	TÜV (R50122733)



SVHC Compliant

Electrical Characteristics (23°C)

Part Number	Hold Current I _H , A	Trip Current I _T , A	Max. Time to trip at 5xI _H , s	Max. Current I _{MAX} , A	Max. Oper. Voltage V _{MAX} , V _{AC/DC}	Max. Int. Voltage V _{I-MAX} , V _{AC/DC}	Typ. Power Pd, W	Resistance	
								R _{MIN} Ohms	R _{1MAX} Ohms
FRVL010-120F	0.10	0.20	10.0	2.0	120	135	0.84	3.00	7.50
FRVL017-120F	0.17	0.34	10.0	2.0	120	135	0.84	2.00	7.00
FRVL020-120F	0.20	0.40	9.0	2.0	120	135	1.08	1.83	4.40
FRVL025-120F	0.25	0.50	7.5	3.0	120	135	1.08	1.25	3.00
FRVL030-120F	0.30	0.60	8.5	3.0	120	135	1.44	0.88	2.10
FRVL040-120F	0.40	0.80	6.5	3.0	120	135	1.44	0.55	1.29
FRVL050-120F	0.50	1.00	6.0	3.0	120	135	1.56	0.50	1.17
FRVL065-120F	0.65	1.30	5.7	5.0	120	135	1.68	0.31	0.72
FRVL070-120F	0.75	1.50	6.3	5.0	120	135	1.80	0.25	0.60
FRVL075-120F	0.75	1.50	15.0	7.5	120	135	2.64	0.25	0.69
FRVL090-120F	0.90	1.80	7.2	5.0	120	135	1.80	0.20	0.47
FRVL100-120F	1.00	2.00	15.0	10.0	120	135	2.64	0.18	0.47
FRVL110-120F	1.10	2.20	8.2	8.0	120	135	2.28	0.15	0.38
FRVL125-120F	1.25	2.50	20.0	12.5	120	135	2.88	0.11	0.33
FRVL130-120F	1.35	2.70	9.6	10.0	120	135	2.64	0.12	0.30
FRVL135-120F	1.35	2.70	20.0	13.5	120	135	3.12	0.11	0.30
FRVL160-120F	1.60	3.20	11.4	12.0	120	135	3.12	0.09	0.22
FRVL185-120F	1.85	3.70	12.6	12.0	120	135	3.36	0.08	0.19
FRVL200-120F	2.00	4.20	36.0	20.0	120	135	4.32	0.08	0.21
FRVL250-120F	2.50	5.00	15.6	15.0	120	135	4.44	0.05	0.13
FRVL300-120F	3.00	6.00	19.8	17.0	120	135	4.56	0.04	0.10
FRVL375-120F	3.75	7.50	24.0	20.0	120	135	4.80	0.03	0.08

Thermal Derating for PPTC Device at Various Ambient Temperatures

TEMPERATURE	-40°C	-20°C	0°C	23°C	30°C	40°C	50°C	60°C	70°C	85°C
DERATING %	158%	138%	119%	100%	90%	80%	70%	60%	50%	38%

Typical Time-To-Trip at 23°C

- A = FRVL010-120F J = FRVL090-120F
- B = FRVL017-120F K = FRVL110-120F
- C = FRVL020-120F L = FRVL130-120F
- D = FRVL025-120F M = FRVL160-120F
- E = FRVL030-120F N = FRVL185-120F
- F = FRVL040-120F O = FRVL250-120F
- G = FRVL050-120F P = FRVL300-120F
- H = FRVL065-120F Q = FRVL375-120F
- I = FRVL070-120F

- R = FRVL075-120F
- S = FRVL100-120F
- T = FRVL125-120F
- U = FRVL135-120F
- V = FRVL200-120F

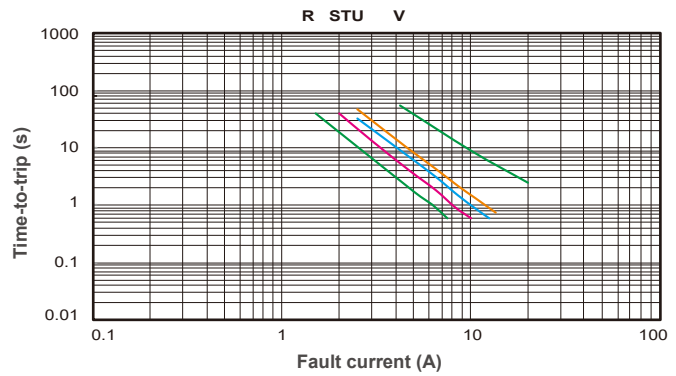
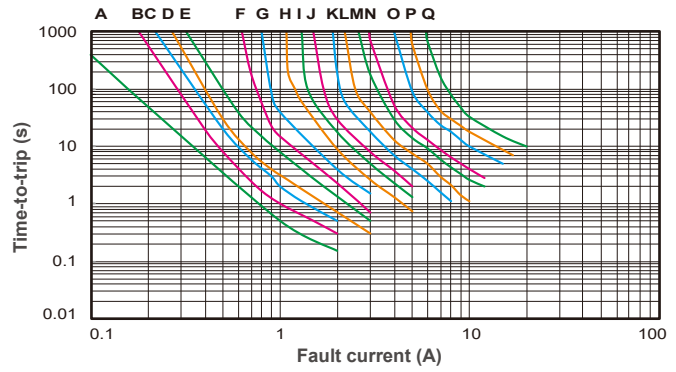

FRVL Product Dimensions (mm)

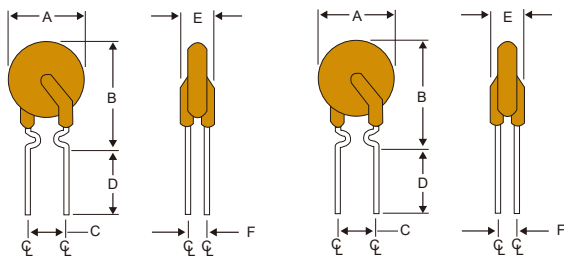

Fig.1
Lead Size : 24AWG
Φ 0.51 mm Diameter

Fig.2
Lead Size : 22AWG
Φ 0.65 mm Diameter

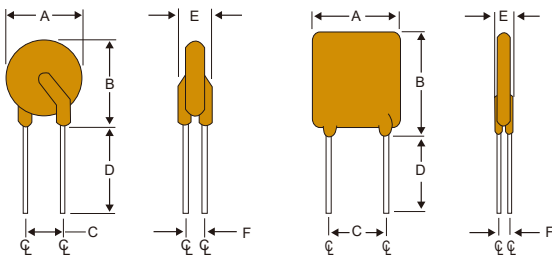
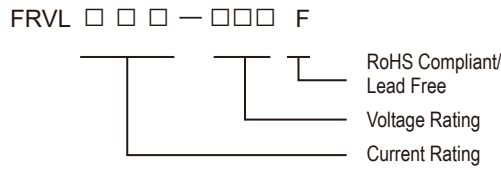

Fig.3
Lead Size : 20AWG
Φ 0.81 mm Diameter

Fig.4
Lead Size : 20AWG
Φ 0.81 mm Diameter

Part Number	Fig.	A	B	C	D	E	F
		Max.	Max.	Typ.	Min.	Max.	Typ.
FRVL010-120F	1	7.9	13.0	5.1	7.6	3.8	2.2
FRVL017-120F	1	7.9	13.0	5.1	7.6	3.8	2.2
FRVL020-120F	2	7.9	13.0	5.1	7.6	3.8	2.2
FRVL025-120F	2	7.9	13.0	5.1	7.6	3.8	2.2
FRVL030-120F	2	7.9	13.0	5.1	7.6	3.8	2.2
FRVL040-120F	2	8.2	14.2	5.1	7.6	3.8	2.2
FRVL050-120F	2	9.2	14.9	5.1	7.6	3.8	2.2
FRVL065-120F	2	9.7	14.9	5.1	7.6	3.8	2.2
FRVL070-120F	2	10.6	15.5	5.1	7.6	3.8	2.2
FRVL075-120F	4	10.9	17.0	5.1	7.6	4.1	2.2
FRVL090-120F	2	11.9	15.9	5.1	7.6	3.8	2.2
FRVL100-120F	4	11.5	20.1	5.1	7.6	4.1	2.2
FRVL110-120F	3	13.3	18.3	5.1	7.6	4.1	2.2
FRVL125-120F	4	14.0	21.7	5.1	7.6	4.1	2.2
FRVL130-120F	3	15.5	20.6	5.1	7.6	4.1	2.2
FRVL135-120F	4	16.3	21.7	5.1	7.6	4.1	2.2
FRVL160-120F	3	17.5	22.5	5.1	7.6	4.1	2.2
FRVL185-120F	3	19.9	24.9	5.1	7.6	4.1	2.2
FRVL200-120F	4	23.5	27.9	10.2	7.6	4.1	2.2
FRVL250-120F	3	22.5	27.5	10.2	7.6	4.1	2.2
FRVL300-120F	3	25.5	30.0	10.2	7.6	4.1	2.2
FRVL375-120F	3	29.5	34.0	10.2	7.6	4.1	2.2

Part Numbering System



Part Marking System

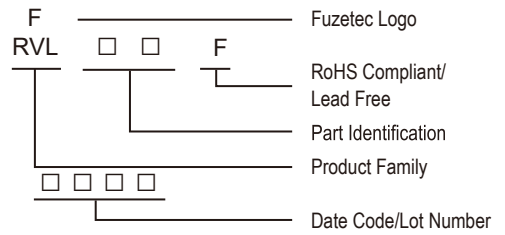

Package Information

Part Number	Standard Package
FRVL010-120F~FRVL050-120F	: 500 Pcs/Bag, 2.0K Reel/Tape
FRVL065-120F~FRVL075-120F	: 300 Pcs/Bag, 1.5K Reel/Tape
FRVL090-120F	: 300 Pcs/Bag, 2.0K Reel/Tape
FRVL100-120F~FRVL110-120F	: 300 Pcs/Bag, 1.5K Reel/Tape
FRVL125-120F~FRVL135-120F	: 200 Pcs/Bag, 1.0K Reel/Tape
FRVL160-120F	: 200 Pcs/Bag
FRVL185-120F~FRVL375-120F	: 100 Pcs/Bag

Physical specifications

Lead material	FRVL010-120F Tin plated copper clad steel, 24AWG.
	FRVL017-120F Tin plated copper, 24AWG.
	FRVL020-120F~FRVL070-120F and FRVL090-120F Tin plated copper, 22AWG.
	FRVL075-120F and FRVL100-120F~FRVL375-120F Tin plated copper, 20AWG.
Soldering characteristics	MIL-STD-202, Method 208E.
Insulating coating	Flame retardant epoxy, meets UL-94V-0 requirement.

Warning :



- Each product should be carefully evaluated and tested for their suitability of application.
- Operation beyond the specified maximum ratings or improper use may result in damage and possible electrical arcing and/or flame.
- PPTC device are intended for occasional overcurrent protection. Application for repeated overcurrent condition and/or prolonged trip are not anticipated.
- Avoid contact of PPTC device with chemical solvent, including some inert material such as silicone based oil, lubricant and etc. Prolonged contact will damage the device performance.
- Additional protection mechanism are strongly recommended to be used in conjunction with the PPTC device for protection against abnormal or failure conditions.
- Avoid use of PPTC device in a constrained space such as potting material, housing and containers where have limited space to accommodate device thermal expansion and/or contraction.



FUZETEC

Package Size: 2920 - 0201

Current Rating: Up to 5A

Voltage Rating: 6 - 60V

SMD PPTC
Series

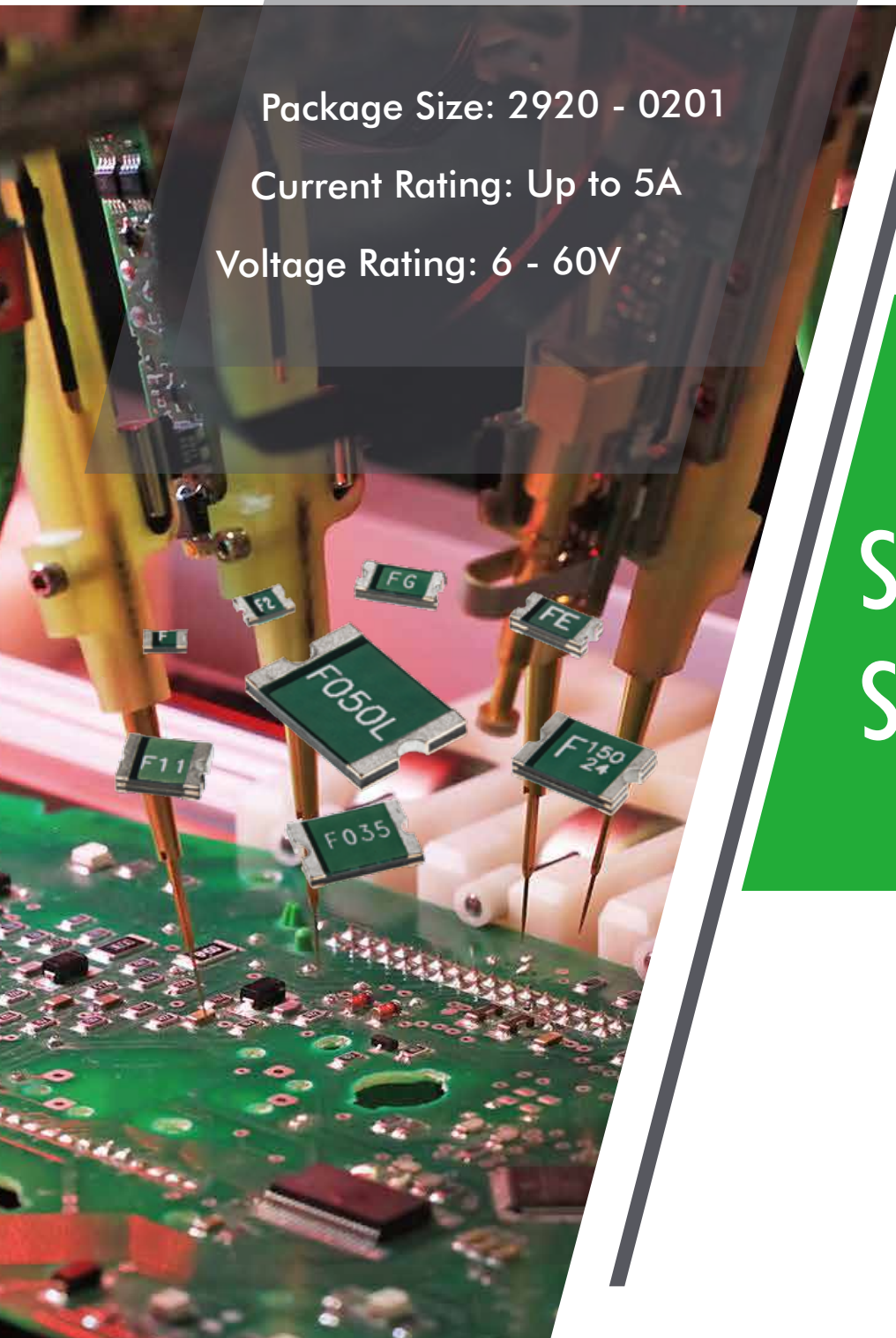

FSMD2920 Series



Application

All high-density boards

Product Features

2920 Dimension, Surface mountable, Solid state, Faster time to trip than standard SMD devices.



Operation Current

0.30A~5.00A

Maximum Voltage

6V~60V_{DC}



Temperature Range

-40°C to 85°C

Agency Recognition

AGENCY	AGENCY FILE NUMBER
	UL(E211981)
	C-UL(E211981)
	TÜV (R50090556)



Electrical Characteristics (23°C)

Part Number	Hold Current	Trip Current	Rated Voltage	Max. Current	Typ. Power	Max. Time to trip		Resistance	
						Current	Time	R _{MIN}	R _{1MAX}
								A	Sec
FSMD030-2920-R	0.30	0.60	60	100	1.5	1.5	3.0	1.000	4.800
FSMD050-2920-R	0.50	1.00	60	100	1.5	2.5	4.0	0.300	1.400
FSMD075-2920-R	0.75	1.50	33	100	1.5	8.0	0.3	0.180	1.000
FSMD075-60-2920-R	0.75	1.50	60	100	1.5	8.0	0.3	0.180	1.000
FSMD100-2920-R	1.10	2.20	33	100	1.5	8.0	0.5	0.090	0.410
FSMD110-60-2920R	1.10	2.20	60	100	1.5	8.0	0.5	0.090	0.410
FSMD125-2920-R	1.25	2.50	33	100	1.5	8.0	2.0	0.050	0.250
FSMD150-2920-R	1.50	3.00	33	100	1.5	8.0	2.0	0.050	0.230
FSMD185-2920-R	1.85	3.70	33	100	1.5	8.0	2.5	0.040	0.150
FSMD200-2920-R	2.00	4.00	16	100	1.5	8.0	5.0	0.035	0.120
FSMD200-24-2920-R	2.00	4.00	24	100	1.5	8.0	5.0	0.035	0.120
FSMD250-2920-R	2.50	5.00	16	100	1.5	8.0	16.0	0.025	0.085
FSMD260-2920-R	2.60	5.20	6	100	1.5	8.0	20.0	0.020	0.075
FSMD260-24-2920R	2.60	5.20	24	100	1.5	8.0	20.0	0.020	0.075
FSMD300-2920-R	3.00	5.20	6	100	1.5	8.0	25.0	0.010	0.048
FSMD300-15-2920R	3.00	5.20	15	100	1.5	8.0	20.0	0.010	0.048
FSMD300-24-2920R	3.00	5.20	24	100	1.5	8.0	20.0	0.010	0.048
FSMD330-2920R	3.30	5.50	24	100	1.5	8.0	20.0	0.010	0.048
FSMD400-16-2920R	4.00	8.00	16	100	1.5	20.0	4.0	0.010	0.040
FSMD500-16-2920R	5.00	10.00	16	100	1.5	20.0	5.0	0.005	0.025

Thermal Derating for PPTC Device at Various Ambient Temperatures

TEMPERATURE	-40°C	-20°C	0°C	23°C	30°C	40°C	50°C	60°C	70°C	85°C
DERATING %	145%	130%	115%	100%	92%	85%	78%	70%	62%	50%

Typical Time-To-Trip at 23°C

- A = FSMD030-2920-R
- B = FSMD050-2920-R
- C = FSMD075-2920-R / 075-60-2920-R
- D = FSMD100-2920-R / 300-15-2920R
- E = FSMD110-60-2920R / 300-24-2920R
- F = FSMD125-2920-R
- G = FSMD150-2920-R
- H = FSMD185-2920-R
- I = FSMD200-2920-R / 200-24-2920-R
- J = FSMD250-2920-R
- K = FSMD260-2920-R / 260-24-2920R
- L = FSMD300-2920R / 300-15-2920R
- M = FSMD330-2920R
- N = FSMD400-16-2920R
- O = FSMD500-16-2920R

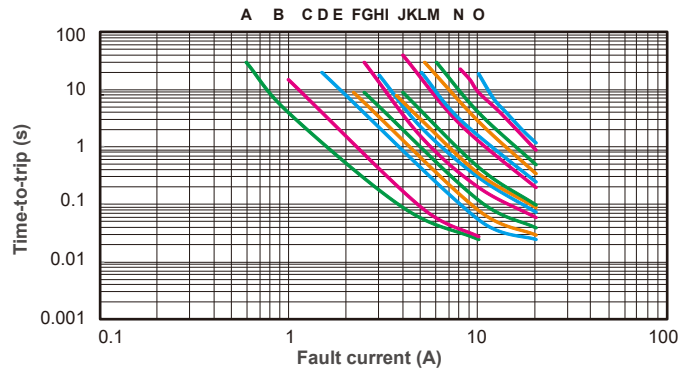

FSMD2920 Product Dimensions (mm)

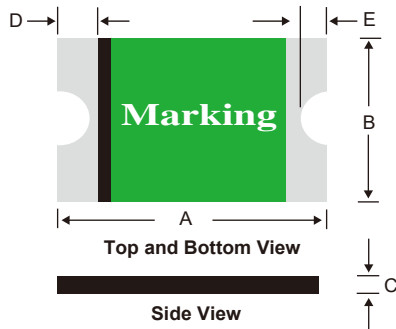

*For Reflow Soldering Profile information, please refer to P.80 “ IX APPENDIX - SMD PRODUCT SOLDER REFLOW RECOMMENDATIONS ”

Part Number	A		B		C		D		E	
	Min.	Max.	Min.	Max.	Min.	Max.	Min.	Max.	Min.	Max.
FSMD030-2920-R	6.73	7.98	4.80	5.44	0.60	1.15	0.50	1.20	0.50	0.90
FSMD050-2920-R	6.73	7.98	4.80	5.44	0.60	1.15	0.50	1.20	0.50	0.90
FSMD075-2920-R	6.73	7.98	4.80	5.44	0.40	1.15	0.50	1.20	0.50	0.90
FSMD075-60-2920-R	6.73	7.98	4.80	5.44	0.60	1.15	0.50	1.20	0.50	0.90
FSMD100-2920-R	6.73	7.98	4.80	5.44	0.40	1.00	0.50	1.20	0.50	0.90
FSMD110-60-2920R	6.73	7.98	4.80	5.44	0.40	1.70	0.50	1.20	0.50	0.90
FSMD125-2920-R	6.73	7.98	4.80	5.44	0.40	0.90	0.50	1.20	0.50	0.90
FSMD150-2920-R	6.73	7.98	4.80	5.44	0.40	0.90	0.50	1.20	0.50	0.90
FSMD185-2920-R	6.73	7.98	4.80	5.44	0.30	0.90	0.50	1.20	0.50	0.90
FSMD200-2920-R	6.73	7.98	4.80	5.44	0.30	0.90	0.50	1.20	0.50	0.90
FSMD200-24-2920-R	6.73	7.98	4.80	5.44	0.20	0.80	0.50	1.20	0.50	0.90
FSMD250-2920-R	6.73	7.98	4.80	5.44	0.30	0.90	0.50	1.20	0.50	0.90
FSMD260-2920-R	6.73	7.98	4.80	5.44	0.30	0.90	0.50	1.20	0.50	0.90
FSMD260-24-2920R	6.73	7.98	4.80	5.44	0.65	1.15	0.50	1.20	0.50	0.90
FSMD300-2920-R	6.73	7.98	4.80	5.44	0.40	0.90	0.50	1.20	0.50	0.90
FSMD300-15-2920R	6.73	7.98	4.80	5.44	0.40	1.15	0.50	1.20	0.50	0.90
FSMD300-24-2920R	6.73	7.98	4.80	5.44	0.65	1.15	0.50	1.20	0.50	0.90
FSMD330-2920R	6.73	7.98	4.80	5.44	0.65	1.15	0.50	1.20	0.50	0.90
FSMD400-16-2920R	6.73	7.98	4.80	5.44	0.40	1.50	0.50	1.20	0.50	0.90
FSMD500-16-2920R	6.73	7.98	4.80	5.44	0.40	1.50	0.50	1.20	0.50	0.90

Part Numbering System

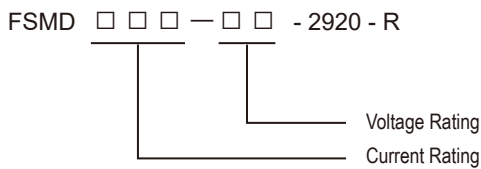

Part Marking System

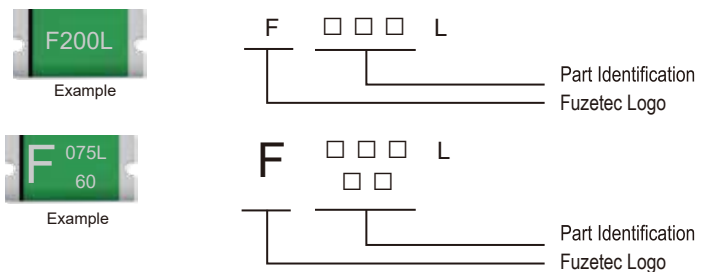

Package Information

Part Number	Standard Package
FSMD030-2920-R~FSMD100-2920-R	: 2.0K Reel/Tape
FSMD110-60-2920R	: 1.0K Reel/Tape
FSMD125-2920-R~FSMD330-2920R	: 2.0K Reel/Tape
FSMD400-16-2920R~FSMD500-16-2920R	: 1.0K Reel/Tape

Physical specifications

Termination pad materials	Pure Tin
Soldering characteristics	Meets EIA specification RS 186-9E, ANSI/J-std-002 Category 3

Warning :



- Each product should be carefully evaluated and tested for their suitability of application.
- Operation beyond the specified maximum ratings or improper use may result in damage and possible electrical arcing and/or flame.
- PPTC device are intended for occasional overcurrent protection. Application for repeated overcurrent condition and/or prolonged trip are not anticipated.
- Avoid contact of PPTC device with chemical solvent, including some inert material such as silicone based oil, lubricant and etc. Prolonged contact will damage the device performance.
- Additional protection mechanism are strongly recommended to be used in conjunction with the PPTC device for protection against abnormal or failure conditions.
- Avoid use of PPTC device in a constrained space such as potting material, housing and containers where have limited space to accommodate device thermal expansion and/or contraction.

NOTE : All Specifications subject to change without notice.

FSMD240V_{AC} Series



Application

All high-density boards

Product Features

2920 Dimension, Surface mountable, Solid state, Faster time to trip than standard SMD devices.



Operation Current

50~160mA

Maximum Voltage

240V_{AC}/250V_{AC}



Temperature Range

-40°C to 85°C

Agency Recognition

AGENCY	AGENCY FILE NUMBER
	UL(E211981)
	C-UL(E211981)
	TÜV (R50090556)



Electrical Characteristics (23°C)

Part Number	Hold Current I _H ,A	Trip Current I _T ,A	Max. Time to trip		Max. Current I _{MAX} ,A	Max. Oper. Voltage V _{MAX} ,V _{AC}	Max. Int. Voltage V _{I-MAX} ,V _{AC}	Type. Power Pd,W	Resistance		
			Current A	Time Sec					R _{MIN}	R _{MAX}	R1 _{MAX}
FSMD005-240-2920-R	0.05	0.12	0.25	15.00	1.0	240	250	1.5	10.0	55.0	70.0
FSMD008-240-2920-R	0.08	0.19	0.40	15.00	1.2	240	250	1.5	6.0	16.0	25.0
FSMD012-240-2920-R	0.12	0.30	0.60	15.00	1.2	240	250	1.5	6.0	14.0	20.0
FSMD013-240-2920-R	0.13	0.32	0.65	15.00	1.2	240	250	1.5	2.0	6.0	12.0
FSMD016-240-2920-R	0.16	0.37	0.80	15.00	2.0	240	250	1.5	2.0	5.0	11.0

Thermal Derating for PPTC Device at Various Ambient Temperatures

TEMPERATURE	-40°C	-20°C	0°C	23°C	30°C	40°C	50°C	60°C	70°C	85°C
DERATING %	157%	133%	118%	100%	90%	81%	70%	60%	51%	36%

Typical Time-To-Trip at 23°C

- A = FSMD005-240-2920-R
- B = FSMD008-240-2920-R
- C = FSMD012-240-2920-R
- D = FSMD013-240-2920-R
- E = FSMD016-240-2920-R

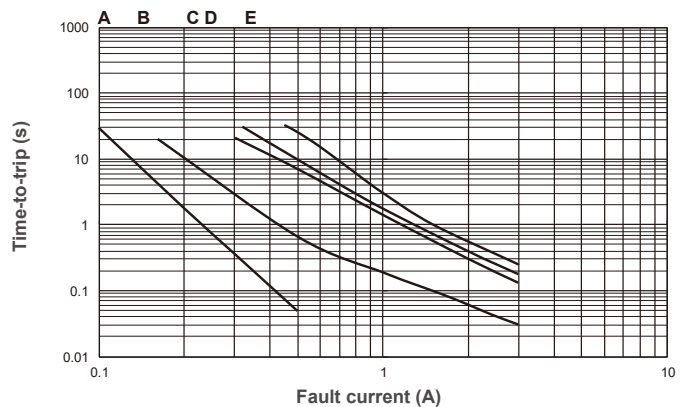

FSMD Product Dimensions (mm)

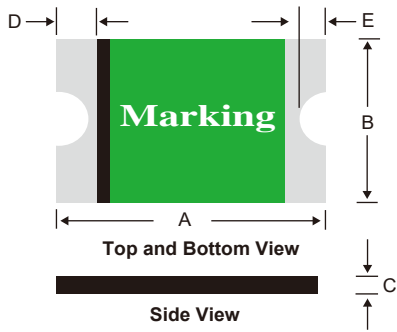

Part Number	A		B		C		D		E	
	Min.	Max.	Min.	Max.	Min.	Max.	Min.	Max.	Min.	Max.
FSMD005-240-2920-R	6.73	7.98	4.80	5.44	2.00	2.60	0.50	1.20	0.50	0.90
FSMD008-240-2920-R	6.73	7.98	4.80	5.44	2.00	2.60	0.50	1.20	0.50	0.90
FSMD012-240-2920-R	6.73	7.98	4.80	5.44	2.00	2.60	0.50	1.20	0.50	0.90
FSMD013-240-2920-R	6.73	7.98	4.80	5.44	2.00	2.60	0.50	1.20	0.50	0.90
FSMD016-240-2920-R	6.73	7.98	4.80	5.44	2.00	2.60	0.50	1.20	0.50	0.90

*For Reflow Soldering Profile information, please refer to P.80 "IX APPENDIX – SMD PRODUCT SOLDER REFLOW RECOMMENDATIONS "

Part Numbering System

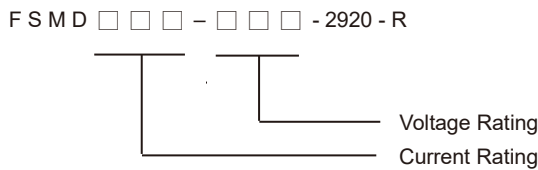

Part Marking System

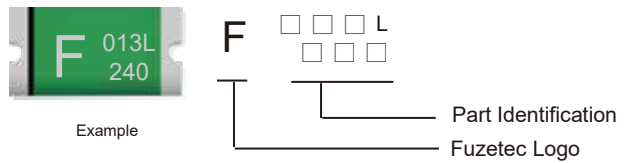

Physical specifications

Termination pad materials	Pure Tin
Soldering characteristics	Meets EIA specification RS 186-9E, ANSI/J-std-002 Category 3



- Warning :**
- Each product should be carefully evaluated and tested for their suitability of application.
 - Operation beyond the specified maximum ratings or improper use may result in damage and possible electrical arcing and/or flame.
 - PPTC device are intended for occasional overcurrent protection. Application for repeated overcurrent condition and/or prolonged trip are not anticipated.
 - Avoid contact of PPTC device with chemical solvent, including some inert material such as silicone based oil, lubricant and etc. Prolonged contact will damage the device performance.
 - Additional protection mechanism are strongly recommended to be used in conjunction with the PPTC device for protection against abnormal or failure conditions.
 - Avoid use of PPTC device in a constrained space such as potting material, housing and containers where have limited space to accommodate device thermal expansion and/or contraction.

FSMD2016 Series



Application

All high-density boards

Product Features

Small surface mount, Solid state, Faster time to trip than standard SMD devices, Lower resistance than standard SMD devices



Operation Current

0.30A~2.00A

Maximum Voltage

6V~60V_{DC}



Temperature Range

-40°C to 85°C

Agency Recognition

AGENCY	AGENCY FILE NUMBER
	UL(E211981)
	C-UL(E211981)
	TÜV (R50090556)



Electrical Characteristics (23°C)

Part Number	Hold Current	Trip Current	Rated Voltage	Max. Current	Typ. Power	Max. Time to trip		Resistance	
						Current	Time	R _{MIN}	R _{1MAX}
						A	Sec	Ohms	Ohms
FSMD030-2016-R	0.30	0.60	60	100	1.4	1.5	3.0	0.400	2.300
FSMD050-2016R	0.55	1.10	60	100	1.4	2.5	5.0	0.200	1.000
FSMD075-2016R	0.75	1.50	60	100	1.4	8.0	0.5	0.130	0.900
FSMD100-2016-R	1.10	2.20	15	100	1.4	8.0	0.5	0.070	0.400
FSMD100-33-2016-R	1.10	2.20	33	100	1.4	8.0	0.5	0.070	0.400
FSMD150-2016-R	1.50	3.00	15	100	1.4	8.0	0.8	0.050	0.180
FSMD200-2016-R	2.00	4.20	6	100	1.4	8.0	3.0	0.030	0.100

Thermal Derating for PPTC Device at Various Ambient Temperatures

TEMPERATURE	-40°C	-20°C	0°C	23°C	30°C	40°C	50°C	60°C	70°C	85°C
DERATING %	157%	133%	118%	100%	90%	81%	70%	60%	51%	36%

Typical Time-To-Trip at 23°C

- A = FSMD030-2016-R
- B = FSMD050-2016R
- C = FSMD075-2016R
- D = FSMD100-2016-R
- E = FSMD100-33-2016-R
- F = FSMD150-2016-R
- G = FSMD200-2016-R

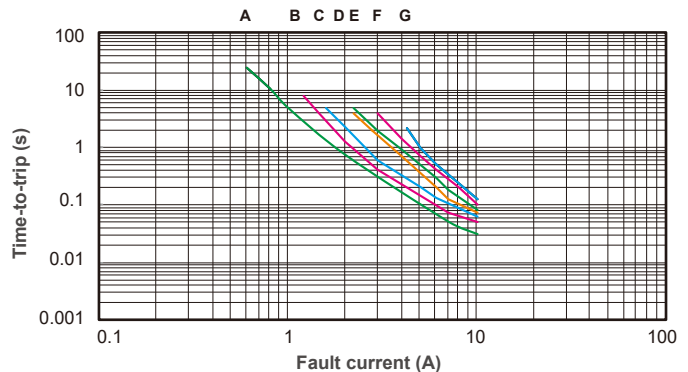

FSMD2016 Product Dimensions (mm)

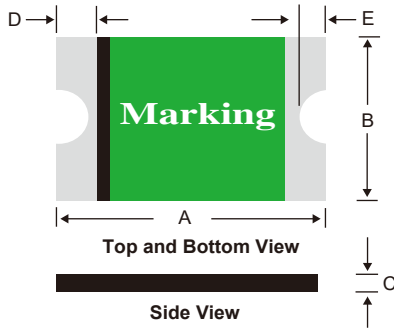

Part Number	A		B		C		D		E	
	Min.	Max.	Min.	Max.	Min.	Max.	Min.	Max.	Min.	Max.
FSMD030-2016-R	4.72	5.44	3.70	4.43	0.40	1.15	0.30	1.50	0.25	0.65
FSMD050-2016R	4.72	5.44	3.70	4.43	0.40	1.70	0.30	1.50	0.25	0.65
FSMD075-2016R	4.72	5.44	3.70	4.43	0.40	1.70	0.30	1.50	0.25	0.65
FSMD100-2016-R	4.72	5.44	3.70	4.43	0.30	0.70	0.30	1.50	0.25	0.65
FSMD100-33-2016-R	4.72	5.44	3.70	4.43	0.30	0.70	0.30	1.50	0.25	0.65
FSMD150-2016-R	4.72	5.44	3.70	4.43	0.25	0.65	0.30	1.50	0.25	0.65
FSMD200-2016-R	4.72	5.44	3.70	4.43	0.25	0.55	0.30	1.50	0.25	0.65

*For Reflow Soldering Profile information, please refer to P.80 "IX APPENDIX – SMD PRODUCT SOLDER REFLOW RECOMMENDATIONS "

Part Numbering System

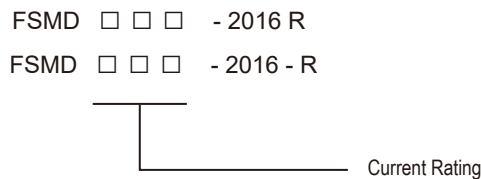

OR

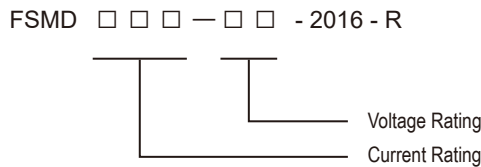

Part Marking System

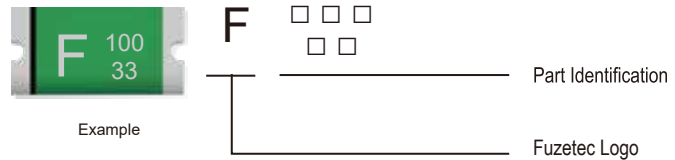
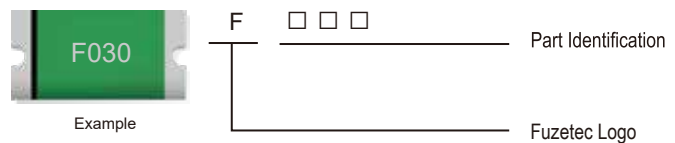

Package Information

Part Number	Standard Package
FSMD030-2016-R	: 2.0K Reel/Tape
FSMD050-2016R~FSMD075-2016R	: 1.0K Reel/Tape
FSMD100-2016-R~FSMD200-2016-R	: 2.0K Reel/Tape

Physical specifications

Termination pad materials	Pure Tin
Soldering characteristics	Meets EIA specification RS 186-9E, ANSI/J-std-002 Category 3

Warning :



- Each product should be carefully evaluated and tested for their suitability of application.
- Operation beyond the specified maximum ratings or improper use may result in damage and possible electrical arcing and/or flame.
- PPTC device are intended for occasional overcurrent protection. Application for repeated overcurrent condition and/or prolonged trip are not anticipated.
- Avoid contact of PPTC device with chemical solvent, including some inert material such as silicone based oil, lubricant and etc. Prolonged contact will damage the device performance.
- Additional protection mechanism are strongly recommended to be used in conjunction with the PPTC device for protection against abnormal or failure conditions.
- Avoid use of PPTC device in a constrained space such as potting material, housing and containers where have limited space to accommodate device thermal expansion and/or contraction.

FSMD1812 Series

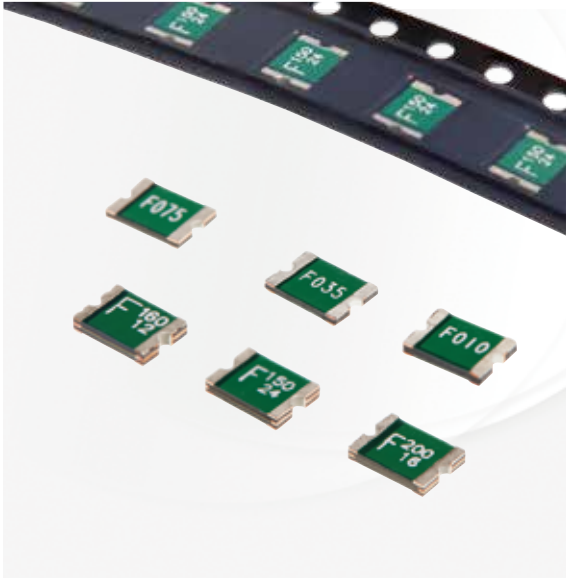

Application

All high-density boards

Product Features

Small surface mount, Solid state Faster time to trip than standard SMD devices Lower resistance than standard SMD devices



Operation Current

0.10A~3.00A

Maximum Voltage

6V~60V_{DC}



Temperature Range

-40°C to 85°C

Agency Recognition

AGENCY	AGENCY FILE NUMBER
	UL(E211981)
	C-UL(E211981)
	TÜV (R50004084/R50090556)



SVHC Compliant

Electrical Characteristics (23°C)

Part Number	Hold Current I _H , A	Trip Current I _T , A	Rated Voltage V _{MAX} , V _{DC}	Max. Current I _{MAX} , A	Typ. Power Pd, W	Max. Time to trip		Resistance	
						Current A	Time Sec	R _{MIN} Ohms	R _{1MAX} Ohms
FSMD010-R	0.10	0.30	60.0	100	0.8	8.0	0.020	1.600	15.000
FSMD014-R	0.14	0.30	60.0	100	0.8	8.0	0.008	1.200	6.500
FSMD020-R	0.20	0.40	30.0	100	0.8	8.0	0.020	0.800	5.000
FSMD020-60-R	0.20	0.40	60.0	100	0.8	8.0	0.020	0.800	5.000
FSMD030-R	0.30	0.60	30.0	100	0.8	8.0	0.100	0.200	1.750
FSMD035-R	0.35	0.70	16.0	100	0.8	8.0	0.100	0.320	1.500
FSMD035-30-R	0.35	0.70	30.0	100	0.8	8.0	0.100	0.320	1.500
FSMD050-R	0.50	1.00	16.0	100	0.8	8.0	0.150	0.150	1.000
FSMD050-30-R	0.50	1.00	30.0	100	0.8	8.0	0.150	0.150	1.000
FSMD075-R	0.75	1.50	16.0	100	0.8	8.0	0.200	0.110	0.450
FSMD075-24R	0.75	1.50	24.0	100	1.0	8.0	0.200	0.110	0.290
FSMD075-33R	0.75	1.50	33.0	100	1.0	8.0	0.200	0.110	0.400
FSMD110-R	1.10	2.20	8.0	100	0.8	8.0	0.300	0.040	0.210
FSMD110-16-R	1.10	2.20	16.0	100	0.8	8.0	0.500	0.060	0.180
FSMD110-24R	1.10	2.20	24.0	100	1.0	8.0	0.500	0.060	0.200
FSMD110-33R	1.10	2.20	33.0	100	0.8	8.0	0.500	0.060	0.200
FSMD125-R	1.25	2.50	6.0	100	0.8	8.0	0.400	0.050	0.140
FSMD125-16R	1.25	2.50	16.0	100	0.8	8.0	0.400	0.050	0.140
FSMD150-R	1.50	3.00	8.0	100	0.8	8.0	0.500	0.040	0.110
FSMD150-12R	1.50	3.00	12.0	100	1.0	8.0	0.500	0.040	0.110
FSMD150-24R	1.50	3.00	24.0	100	1.0	8.0	1.500	0.040	0.120
FSMD160-R	1.60	3.20	8.0	100	0.8	8.0	0.500	0.030	0.100
FSMD160-12R	1.60	3.20	12.0	100	1.0	8.0	1.000	0.030	0.100
FSMD160-16R	1.60	3.20	16.0	100	1.0	8.0	1.000	0.030	0.100
FSMD160-24R	1.60	3.20	24.0	100	1.0	8.0	1.000	0.030	0.100
FSMD200R	2.00	3.50	8.0	100	1.0	8.0	2.000	0.020	0.070
FSMD200-16R	2.00	3.50	16.0	100	1.0	8.0	5.000	0.020	0.085
FSMD260R	2.60	5.00	8.0	100	1.0	8.0	2.500	0.015	0.047
FSMD260-13R	2.60	5.00	13.2	100	1.3	8.0	5.000	0.015	0.050
FSMD260-16R	2.60	5.00	16.0	100	1.3	8.0	5.000	0.015	0.050
FSMD300R	3.00	5.00	6.0	100	1.0	8.0	4.000	0.012	0.040

Thermal Derating for PPTC Device at Various Ambient Temperatures

TEMPERATURE	-40°C	-20°C	0°C	23°C	30°C	40°C	50°C	60°C	70°C	85°C
DERATING %	145%	130%	116%	100%	91%	84%	78%	69%	61%	50%

Typical Time-To-Trip at 23°C

- A = FSMD010-R
- B = FSMD014-R
- C = FSMD020-R / 020-60-R
- D = FSMD030-R
- E = FSMD035-R / 035-30-R
- F = FSMD050-R / 050-30-R
- G = FSMD075-R / 075-24R/075-33R
- H = FSMD110-R / 110-16-R / 110-24R / 110-33R
- I = FSMD125-R / 125-16R
- J = FSMD150-R / 150-12R / 150-24R
- K = FSMD160-R / 160-12R / 160-16R / 160-24R
- L = FSMD200R / 200-16R
- M = FSMD260R / 260-13R / 260-16R
- N = FSMD300R

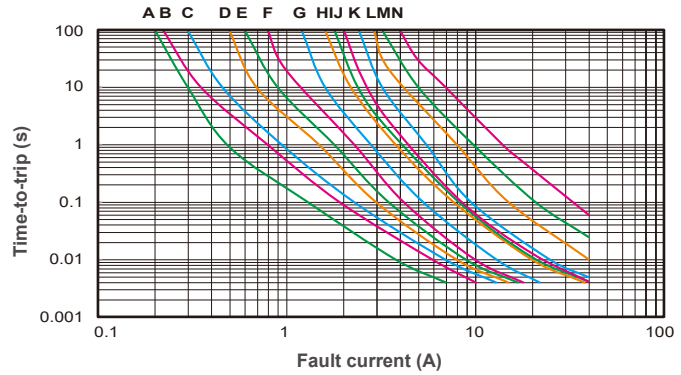

FSMD1812 Product Dimensions (mm)

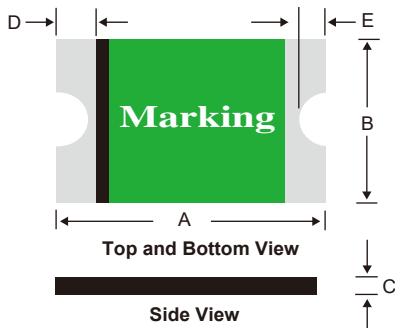

*For Reflow Soldering Profile information, please refer to P.80 " IX APPENDIX - SMD PRODUCT SOLDER REFLOW RECOMMENDATIONS "

Part Number	A		B		C		D		E	
	Min.	Max.	Min.	Max.	Min.	Max.	Min.	Max.	Min.	Max.
FSMD010-R	4.37	4.73	3.07	3.41	0.60	0.90	0.30	0.95	0.25	0.65
FSMD014-R	4.37	4.73	3.07	3.41	0.60	0.90	0.30	0.95	0.25	0.65
FSMD020-R	4.37	4.73	3.07	3.41	0.60	0.90	0.30	0.95	0.25	0.65
FSMD020-60-R	4.37	4.73	3.07	3.41	0.60	0.90	0.30	0.95	0.25	0.65
FSMD030-R	4.37	4.73	3.07	3.41	0.40	0.70	0.30	0.95	0.25	0.65
FSMD035-R	4.37	4.73	3.07	3.41	0.40	0.70	0.30	0.95	0.25	0.65
FSMD035-30-R	4.37	4.73	3.07	3.41	0.40	0.70	0.30	0.95	0.25	0.65
FSMD050-R	4.37	4.73	3.07	3.41	0.35	0.65	0.30	0.95	0.25	0.65
FSMD050-30-R	4.37	4.73	3.07	3.41	0.45	0.75	0.30	0.95	0.25	0.65
FSMD075-R	4.37	4.73	3.07	3.41	0.35	0.65	0.30	0.95	0.25	0.65
FSMD075-24R	4.37	4.73	3.07	3.41	0.80	1.55	0.25	0.95	0.25	0.65
FSMD075-33R	4.37	4.73	3.07	3.41	0.80	1.55	0.25	0.95	0.25	0.65
FSMD110-R	4.37	4.73	3.07	3.41	0.25	0.55	0.30	0.95	0.25	0.65
FSMD110-16-R	4.37	4.73	3.07	3.41	0.25	0.90	0.30	0.95	0.25	0.65
FSMD110-24R	4.37	4.73	3.07	3.41	0.80	1.30	0.25	0.95	0.25	0.65
FSMD110-33R	4.37	4.73	3.07	3.41	0.80	1.30	0.25	0.95	0.25	0.65
FSMD125-R	4.37	4.73	3.07	3.41	0.25	0.55	0.30	0.95	0.25	0.65
FSMD125-16R	4.37	4.73	3.07	3.41	0.50	1.00	0.30	0.95	0.25	0.65
FSMD150-R	4.37	4.73	3.07	3.41	0.25	0.55	0.30	0.95	0.25	0.65
FSMD150-12R	4.37	4.73	3.07	3.41	0.60	1.10	0.25	0.95	0.25	0.65
FSMD150-24R	4.37	4.73	3.07	3.41	0.60	1.55	0.25	0.95	0.25	0.65
FSMD160-R	4.37	4.73	3.07	3.41	0.25	0.90	0.30	0.95	0.25	0.65
FSMD160-12R	4.37	4.73	3.07	3.41	0.60	1.35	0.25	0.95	0.25	0.65
FSMD160-16R	4.37	4.73	3.07	3.41	0.60	1.35	0.25	0.95	0.25	0.65
FSMD160-24R	4.37	4.73	3.07	3.41	0.55	1.20	0.25	0.95	0.25	0.65
FSMD200R	4.37	4.73	3.07	3.41	0.55	1.20	0.25	0.95	0.25	0.65
FSMD200-16R	4.37	4.73	3.07	3.41	0.60	1.55	0.25	0.95	0.25	0.65
FSMD260R	4.37	4.73	3.07	3.41	0.55	1.20	0.25	0.95	0.25	0.65
FSMD260-13R	4.37	4.73	3.07	3.41	0.80	1.55	0.25	0.95	0.25	0.65
FSMD260-16R	4.37	4.73	3.07	3.41	0.80	1.55	0.25	0.95	0.25	0.65
FSMD300R	4.37	4.73	3.07	3.41	0.80	1.55	0.25	0.95	0.25	0.65

Part Numbering System

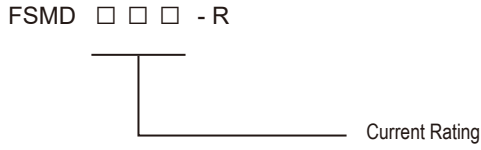

OR

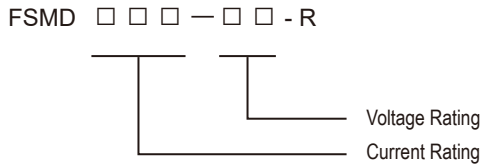

Part Marking System

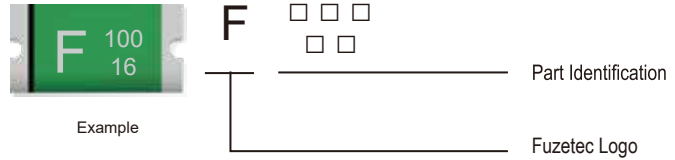
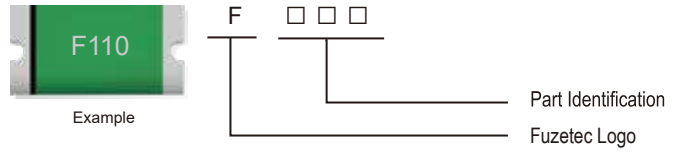

Package Information

Part Number	Standard Package
FSMD010-R-FSMD075-R	: 2.0K Reel/Tape
FSMD075-24R-FSMD075-33R	: 1.5K Reel/Tape
FSMD110-R-FSMD110-16-R	: 2.0K Reel/Tape
FSMD110-24R-FSMD110-33R	: 1.5K Reel/Tape
FSMD125-R	: 2.0K Reel/Tape
FSMD125-16R	: 1.5K Reel/Tape
FSMD150-R-FSMD200R	: 2.0K Reel/Tape
FSMD200-16R	: 1.5K Reel/Tape
FSMD260R	: 2.0K Reel/Tape
FSMD260-13R-FSMD300R	: 1.5K Reel/Tape

Physical specifications

Termination pad materials	Pure Tin
Soldering characteristics	Meets EIA specification RS 186-9E, ANSI/J-std-002 Category 3

Warning :



- Each product should be carefully evaluated and tested for their suitability of application.
- Operation beyond the specified maximum ratings or improper use may result in damage and possible electrical arcing and/or flame.
- PPTC device are intended for occasional overcurrent protection. Application for repeated overcurrent condition and/or prolonged trip are not anticipated.
- Avoid contact of PPTC device with chemical solvent, including some inert material such as silicone based oil, lubricant and etc. Prolonged contact will damage the device performance.
- Additional protection mechanism are strongly recommended to be used in conjunction with the PPTC device for protection against abnormal or failure conditions.
- Avoid use of PPTC device in a constrained space such as potting material, housing and containers where have limited space to accommodate device thermal expansion and/or contraction.

FSMD1210 Series

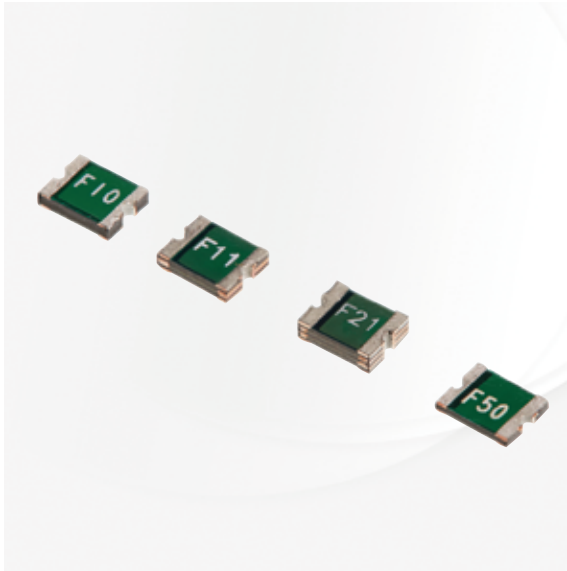

Application

All high-density boards

Product Features

Small surface mount, Solid state Faster time to trip than standard SMD devices Lower resistance than standard SMD devices



Operation Current

0.05A~2.00A

Maximum Voltage

6V~60V_{DC}



Temperature Range

-40°C to 85°C

Agency Recognition

AGENCY	AGENCY FILE NUMBER
	UL(E211981)
	C-UL(E211981)
	TÜV (R50090556)



SVHC Compliant

Electrical Characteristics (23°C)

Part Number	Hold Current I _H , A	Trip Current I _T , A	Rated Voltage V _{MAX} , V _{DC}	Max. Current I _{MAX} , A	Typ. Power Pd, W	Max. Time to trip		Resistance	
						Current A	Time Sec	R _{MIN} Ohms	R _{1MAX} Ohms
FSMD005-1210-R	0.05	0.15	60	100	0.60	0.25	1.50	3.600	50.000
FSMD010-1210-R	0.10	0.25	60	100	0.60	0.50	1.50	1.600	15.000
FSMD020-1210-R	0.20	0.40	30	100	0.60	8.00	0.02	0.800	5.000
FSMD035-1210-R	0.35	0.70	16	100	0.60	8.00	0.20	0.320	1.300
FSMD050-1210-R	0.50	1.00	16	100	0.60	8.00	0.10	0.250	0.900
FSMD075-1210-R	0.75	1.50	8	100	0.60	8.00	0.10	0.130	0.400
FSMD075-24-1210R	0.75	1.50	24	100	0.60	8.00	0.10	0.130	0.400
FSMD110-1210R	1.10	2.20	8	100	0.80	8.00	0.30	0.060	0.210
FSMD110-16-1210R	1.10	2.20	16	100	0.80	8.00	0.30	0.060	0.210
FSMD150-1210R	1.50	3.00	6	100	0.80	8.00	0.50	0.040	0.110
FSMD175-1210R	1.75	3.50	6	100	0.80	8.00	0.60	0.020	0.080
FSMD200-1210R	2.00	4.00	6	100	0.80	8.00	1.00	0.015	0.070

Thermal Derating for PPTC Device at Various Ambient Temperatures

TEMPERATURE	-40°C	-20°C	0°C	23°C	30°C	40°C	50°C	60°C	70°C	85°C
DERATING %	145%	130%	115%	100%	92%	83%	76%	70%	62%	50%

Typical Time-To-Trip at 23°C

- A = FSMD005-1210-R
- B = FSMD010-1210-R
- C = FSMD020-1210-R
- D = FSMD035-1210-R
- E = FSMD050-1210-R
- F = FSMD075-1210-R / 075-24-1210R
- G = FSMD110-1210R / 110-16-1210R
- H = FSMD150-1210R
- I = FSMD175-1210R
- J = FSMD200-1210R

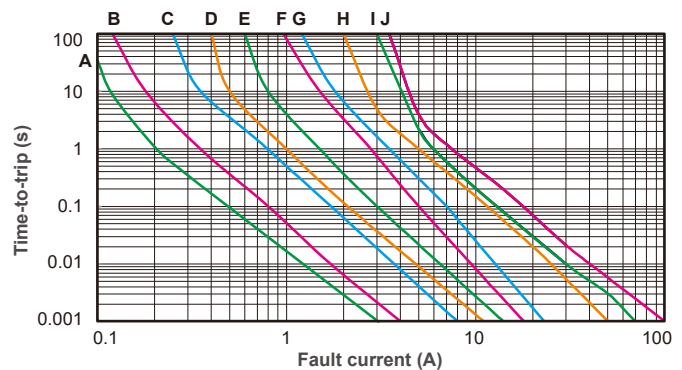

NOTE : All Specifications subject to change without notice.

FSMD1210 Product Dimensions (mm)

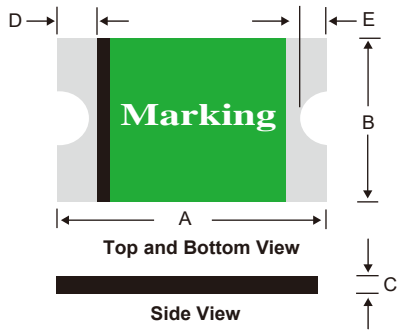

Part Number	A		B		C		D		E	
	Min.	Max.	Min.	Max.	Min.	Max.	Min.	Max.	Min.	Max.
FSMD005-1210-R	3.00	3.43	2.35	2.80	0.60	1.15	0.25	0.75	0.10	0.45
FSMD010-1210-R	3.00	3.43	2.35	2.80	0.60	1.15	0.25	0.75	0.10	0.45
FSMD020-1210-R	3.00	3.43	2.35	2.80	0.40	0.85	0.25	0.75	0.10	0.45
FSMD035-1210-R	3.00	3.43	2.35	2.80	0.40	0.80	0.25	0.75	0.10	0.45
FSMD050-1210-R	3.00	3.43	2.35	2.80	0.30	0.75	0.25	0.75	0.10	0.45
FSMD075-1210-R	3.00	3.43	2.35	2.80	0.30	0.70	0.25	0.75	0.10	0.45
FSMD075-24-1210R	3.00	3.43	2.35	2.80	0.80	1.20	0.25	0.75	0.10	0.45
FSMD110-1210R	3.00	3.43	2.35	2.80	0.60	1.00	0.25	0.75	0.10	0.45
FSMD110-16-1210R	3.00	3.43	2.35	2.80	0.60	1.00	0.25	0.75	0.10	0.45
FSMD150-1210R	3.00	3.43	2.35	2.80	0.50	0.90	0.25	0.75	0.10	0.45
FSMD175-1210R	3.00	3.43	2.35	2.80	0.80	1.40	0.25	0.75	0.10	0.45
FSMD200-1210R	3.00	3.43	2.35	2.80	0.80	1.40	0.25	0.75	0.10	0.45

*For Reflow Soldering Profile information, please refer to P.80 " IX APPENDIX - SMD PRODUCT SOLDER REFLOW RECOMMENDATIONS "

Part Numbering System

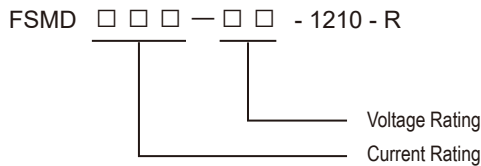

Part Marking System

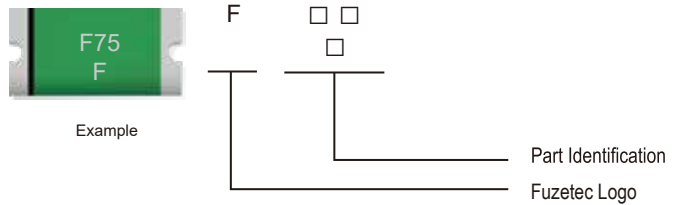
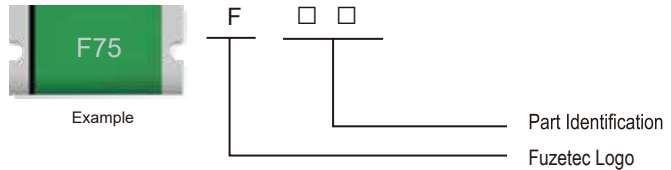

Package Information

Part Number	Standard Package
FSMD005-1210-R~FSMD020-1210-R	: 3.0K Reel/Tape
FSMD035-1210-R~FSMD075-1210-R	: 4.0K Reel/Tape
FSMD075-24-1210R~FSMD200-1210R	: 3.0K Reel/Tape

Physical specifications

Termination pad materials	Pure Tin
Soldering characteristics	Meets EIA specification RS 186-9E, ANSI/J-std-002 Category 3

Warning :



- Each product should be carefully evaluated and tested for their suitability of application.
- Operation beyond the specified maximum ratings or improper use may result in damage and possible electrical arcing and/or flame.
- PPTC device are intended for occasional overcurrent protection. Application for repeated overcurrent condition and/or prolonged trip are not anticipated.
- Avoid contact of PPTC device with chemical solvent, including some inert material such as silicone based oil, lubricant and etc. Prolonged contact will damage the device performance.
- Additional protection mechanism are strongly recommended to be used in conjunction with the PPTC device for protection against abnormal or failure conditions.
- Avoid use of PPTC device in a constrained space such as potting material, housing and containers where have limited space to accommodate device thermal expansion and/or contraction.

FSMD1206 Series



Application

All high-density boards

Product Features

Small surface mount, Solid state Faster time to trip than standard SMD devices Lower resistance than standard SMD devices



Operation Current

0.05A~2.00A

Maximum Voltage

6V~60V_{DC}



Temperature Range

-40°C to 85°C

Agency Recognition

AGENCY	AGENCY FILE NUMBER
	UL(E211981)
	C-UL(E211981)
	TÜV (R50090556)



SVHC Compliant

Electrical Characteristics (23°C)

Part Number	Hold Current	Trip Current	Rated Voltage	Max. Current	Typ. Power	Max. Time to trip		Resistance	
						Current	Time	R _{MIN}	R _{1MAX}
						A	Sec	Ohms	Ohms
FSMD005-1206-R	0.05	0.15	60	100	0.4	0.25	1.50	3.600	50.000
FSMD010-1206-R	0.10	0.25	60	100	0.4	0.50	1.00	1.600	15.000
FSMD012-1206-R	0.12	0.39	48	100	0.5	1.00	0.20	1.400	6.500
FSMD016-1206-R	0.16	0.45	48	100	0.5	1.00	0.30	1.100	5.000
FSMD020-1206-R	0.20	0.40	30	100	0.4	8.00	0.10	0.600	2.500
FSMD025-1206-R	0.25	0.50	16	100	0.6	8.00	0.08	0.550	2.300
FSMD025-24-1206-R	0.25	0.50	24	100	0.6	8.00	0.08	0.550	2.300
FSMD035-1206-R	0.35	0.75	16	100	0.4	8.00	0.10	0.300	1.200
FSMD035-30-1206R	0.35	0.75	30	100	0.6	8.00	0.10	0.300	1.200
FSMD050-1206-R	0.50	1.00	8	100	0.4	8.00	0.10	0.150	0.700
FSMD050-24-1206R	0.50	1.00	24	100	0.6	8.00	0.10	0.150	0.750
FSMD075-1206R	0.75	1.50	8	100	0.6	8.00	0.20	0.090	0.290
FSMD075-16-1206R	0.75	1.50	16	100	0.6	8.00	0.20	0.090	0.290
FSMD100-1206R	1.00	1.80	6	100	0.6	8.00	0.30	0.055	0.210
FSMD110-1206R	1.10	2.20	8	100	0.8	8.00	0.30	0.040	0.180
FSMD110-16-1206R	1.10	2.20	16	100	0.8	8.00	0.30	0.040	0.180
FSMD150-1206R	1.50	3.00	8	100	0.8	8.00	1.00	0.040	0.120
FSMD200-1206R	2.00	3.50	6	100	0.8	8.00	1.50	0.018	0.080

Thermal Derating for PPTC Device at Various Ambient Temperatures

TEMPERATURE	-40°C	-20°C	0°C	23°C	30°C	40°C	50°C	60°C	70°C	85°C
DERATING %	145%	130%	115%	100%	92%	84%	78%	69%	62%	50%

Typical Time-To-Trip at 23°C

- | | |
|--------------------|--------------------|
| Z = FSMD005-1206-R | G = FSMD050-1206-R |
| A = FSMD010-1206-R | / FSMD050-24-1206R |
| B = FSMD012-1206-R | H = FSMD075-1206R |
| C = FSMD016-1206-R | / FSMD075-16-1206 |
| D = FSMD020-1206-R | I = FSMD100-1206R |
| E = FSMD025-1206-R | J = FSMD110-1206R |
| / 025-24-1206-R | / 110-16-1206R |
| F = FSMD035-1206-R | K = FSMD150-1206R |
| / 035-30-1206R | L = FSMD200-1206R |

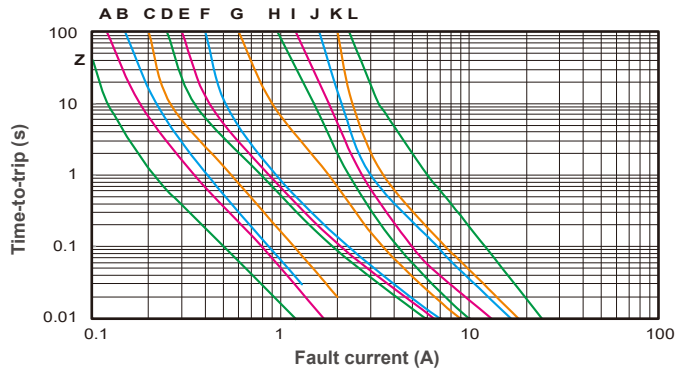

FSMD1206 Product Dimensions (mm)

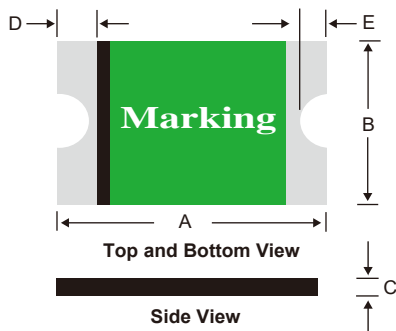

*For Reflow Soldering Profile information, please refer to P.80 "IX APPENDIX - SMD PRODUCT SOLDER REFLOW RECOMMENDATIONS"

Part Number	A		B		C		D		E	
	Min.	Max.	Min.	Max.	Min.	Max.	Min.	Max.	Min.	Max.
FSMD005-1206-R	3.00	3.50	1.50	1.80	0.45	0.85	0.10	0.75	0.10	0.45
FSMD010-1206-R	3.00	3.50	1.50	1.80	0.45	0.85	0.10	0.75	0.10	0.45
FSMD012-1206-R	3.00	3.50	1.50	1.80	0.45	0.85	0.10	0.75	0.10	0.45
FSMD016-1206-R	3.00	3.50	1.50	1.80	0.45	0.75	0.10	0.75	0.10	0.45
FSMD020-1206-R	3.00	3.50	1.50	1.80	0.45	0.75	0.10	0.75	0.10	0.45
FSMD025-1206-R	3.00	3.50	1.50	1.80	0.45	0.75	0.10	0.75	0.10	0.45
FSMD025-24-1206-R	3.00	3.50	1.50	1.80	0.45	0.75	0.10	0.75	0.10	0.45
FSMD035-1206-R	3.00	3.50	1.50	1.80	0.30	0.75	0.10	0.75	0.10	0.45
FSMD035-30-1206R	3.00	3.50	1.50	1.80	0.90	1.30	0.25	0.75	0.10	0.45
FSMD050-1206-R	3.00	3.50	1.50	1.80	0.25	0.55	0.10	0.75	0.10	0.45
FSMD050-24-1206R	3.00	3.50	1.50	1.80	0.80	1.20	0.25	0.75	0.10	0.45
FSMD075-1206R	3.00	3.50	1.50	1.80	0.45	1.25	0.25	0.75	0.10	0.45
FSMD075-16-1206R	3.00	3.50	1.50	1.80	0.45	1.25	0.25	0.75	0.10	0.45
FSMD100-1206R	3.00	3.50	1.50	1.80	0.45	1.00	0.25	0.75	0.10	0.45
FSMD110-1206R	3.00	3.50	1.50	1.80	0.45	1.00	0.25	0.75	0.10	0.45
FSMD110-16-1206R	3.00	3.50	1.50	1.80	0.80	1.40	0.25	0.75	0.10	0.45
FSMD150-1206R	3.00	3.50	1.50	1.80	0.80	1.40	0.25	0.75	0.10	0.45
FSMD200-1206R	3.00	3.50	1.50	1.80	0.85	1.60	0.25	0.75	0.10	0.45

Part Numbering System

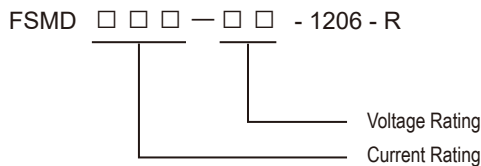

Part Marking System

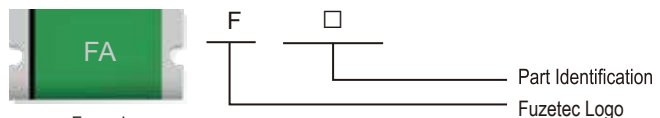

- | | |
|------------------------|-----------------------|
| FZ = FSMD005-1206-R | FD = FSMD050-1206-R |
| FA = FSMD010-1206-R | FN = FSMD050-24-1206R |
| FJ = FSMD012-1206-R | FE = FSMD075-1206R |
| FK = FSMD016-1206-R | FO = FSMD075-16-1206R |
| FB = FSMD020-1206-R | FF = FSMD100-1206R |
| FL = FSMD025-1206-R | FG = FSMD110-1206R |
| FP = FSMD025-24-1206-R | FQ = FSMD110-16-1206R |
| FC = FSMD035-1206-R | FH = FSMD150-1206R |
| FM = FSMD035-30-1206R | FI = FSMD200-1206R |

Package Information

Part Number	Standard Package
FSMD005-1206-R~ FSMD025-24-1206-R	: 3.0K Reel/Tape
FSMD035-1206-R	: 4.0K Reel/Tape
FSMD035-30-1206R	: 3.0K Reel/Tape
FSMD050-1206-R	: 4.0K Reel/Tape
FSMD050-24-1206R~FSMD110-1206R	: 3.0K Reel/Tape
FSMD110-16-1206R~FSMD200-1206R	: 2.0K Reel/Tape

Physical specifications

Termination pad materials	Pure Tin
Soldering characteristics	Meets EIA specification RS 186-9E, ANSI/J-std-002 Category 3

Warning :



- Each product should be carefully evaluated and tested for their suitability of application.
- Operation beyond the specified maximum ratings or improper use may result in damage and possible electrical arcing and/or flame.
- PPTC device are intended for occasional overcurrent protection. Application for repeated overcurrent condition and/or prolonged trip are not anticipated.
- Avoid contact of PPTC device with chemical solvent, including some inert material such as silicone based oil, lubricant and etc. Prolonged contact will damage the device performance.
- Additional protection mechanism are strongly recommended to be used in conjunction with the PPTC device for protection against abnormal or failure conditions.
- Avoid use of PPTC device in a constrained space such as potting material, housing and containers where have limited space to accommodate device thermal expansion and/or contraction.

FSMD0805 Series

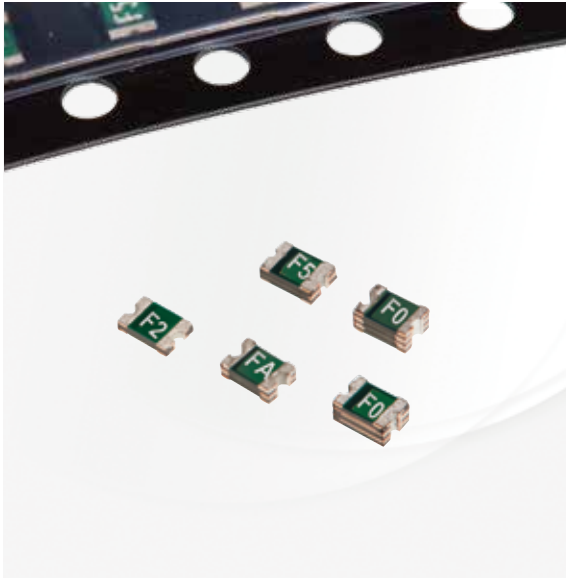

Application

All high-density boards

Product Features

Small surface mountable, Solid state, Faster time to trip than standard SMD devices, Lower resistance than standard SMD devices



Operation Current

0.10A~1.10A

Maximum Voltage

6V~24V_{DC}



Temperature Range

-40°C to 85°C

Agency Recognition

AGENCY	AGENCY FILE NUMBER
	UL(E211981)
	C-UL(E211981)
	TÜV (R50090556)



SVHC Compliant

Electrical Characteristics (23°C)

Part Number	Hold Current	Trip Current	Rated Voltage	Max. Current	Typ. Power	Max. Time to trip		Resistance	
						Current	Time	R _{MIN}	R _{1MAX}
						A	Sec	Ohms	Ohms
FSMD010-0805-R	0.10	0.30	15	100	0.5	0.50	1.50	0.700	6.000
FSMD010-24-0805-R	0.10	0.30	24	100	0.5	0.50	1.50	0.700	6.000
FSMD020-0805-R	0.20	0.50	9	100	0.5	8.00	0.02	0.400	3.500
FSMD035-0805-R	0.35	0.75	6	100	0.5	8.00	0.10	0.250	1.200
FSMD050-0805R	0.50	1.00	6	100	0.5	8.00	0.10	0.150	0.850
FSMD050-9-0805R	0.50	1.00	9	100	0.5	8.00	0.10	0.150	0.850
FSMD075-0805R	0.75	1.50	6	100	0.6	8.00	0.20	0.090	0.350
FSMD100-0805R	1.00	1.95	6	100	0.6	8.00	0.30	0.060	0.210
FSMD110-0805R	1.10	2.20	6	100	0.6	8.00	0.20	0.050	0.200

Thermal Derating for PPTC Device at Various Ambient Temperatures

TEMPERATURE	-40°C	-20°C	0°C	23°C	30°C	40°C	50°C	60°C	70°C	85°C
DERATING %	145%	130%	116%	100%	91%	84%	76%	69%	61%	50%

Typical Time-To-Trip at 23°C

- A = FSMD010-0805-R / FSMD010-24-0805-R
- B = FSMD020-0805-R
- C = FSMD035-0805-R
- D = FSMD050-0805R / FSMD050-9-0805R
- E = FSMD075-0805R
- F = FSMD100-0805R
- G = FSMD110-0805R

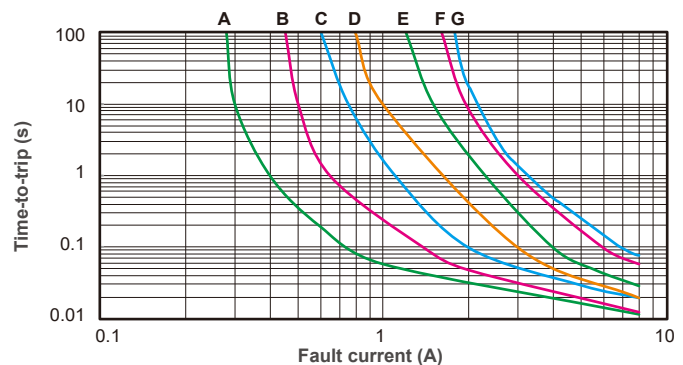

FSMD0805 Product Dimensions (mm)

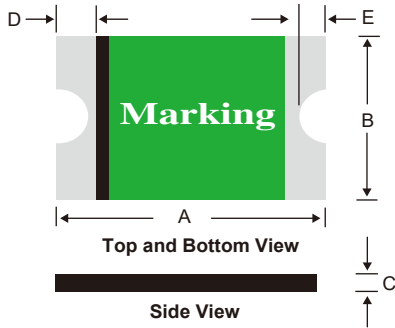

Part Number	A		B		C		D		E	
	Min.	Max.	Min.	Max.	Min.	Max.	Min.	Max.	Min.	Max.
FSMD010-0805-R	2.00	2.30	1.20	1.50	0.30	1.00	0.20	0.60	0.10	0.45
FSMD010-24-0805-R	2.00	2.30	1.20	1.50	0.30	1.00	0.20	0.60	0.10	0.45
FSMD020-0805-R	2.00	2.30	1.20	1.50	0.30	1.00	0.20	0.60	0.10	0.45
FSMD035-0805-R	2.00	2.30	1.20	1.50	0.25	0.75	0.20	0.60	0.10	0.45
FSMD050-0805R	2.00	2.30	1.20	1.50	0.55	1.25	0.20	0.60	0.10	0.45
FSMD050-9-0805R	2.00	2.30	1.20	1.50	0.55	1.25	0.20	0.60	0.10	0.45
FSMD075-0805R	2.00	2.30	1.20	1.50	0.55	1.25	0.20	0.60	0.10	0.45
FSMD100-0805R	2.00	2.30	1.20	1.50	0.75	1.80	0.20	0.60	0.10	0.45
FSMD110-0805R	2.00	2.30	1.20	1.50	0.75	1.80	0.20	0.60	0.10	0.45

*For Reflow Soldering Profile information, please refer to P.80 “ IX APPENDIX - SMD PRODUCT SOLDER REFLOW RECOMMENDATIONS ”

Part Numbering System

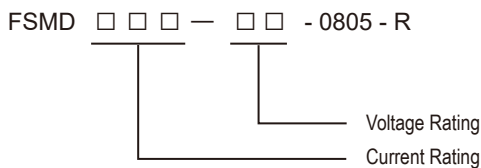

Part Marking System

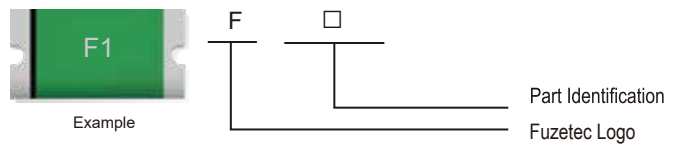

F1 = FSMD010-0805-R	F5 = FSMD050-0805R
FB = FSMD010-24-0805-R	FA = FSMD050-9-0805R
F2 = FSMD020-0805-R	F7 = FSMD075-0805R
F3 = FSMD035-0805-R	F0 = FSMD100-0805R
	FC = FSMD110-0805R

Package Information

Part Number	Standard Package
FSMD010-0805-R-FSMD035-0805-R	: 4.0K Reel/Tape
FSMD050-0805R-FSMD110-0805R	: 3.0K Reel/Tape

Physical specifications

Termination pad materials	Pure Tin
Soldering characteristics	Meets EIA specification RS 186-9E, ANSI/J-std-002 Category 3

Warning :



- Each product should be carefully evaluated and tested for their suitability of application.
- Operation beyond the specified maximum ratings or improper use may result in damage and possible electrical arcing and/or flame.
- PPTC device are intended for occasional overcurrent protection. Application for repeated overcurrent condition and/or prolonged trip are not anticipated.
- Avoid contact of PPTC device with chemical solvent, including some inert material such as silicone based oil, lubricant and etc. Prolonged contact will damage the device performance.
- Additional protection mechanism are strongly recommended to be used in conjunction with the PPTC device for protection against abnormal or failure conditions.
- Avoid use of PPTC device in a constrained space such as potting material, housing and containers where have limited space to accommodate device thermal expansion and/or contraction.

FSMD0603 Series

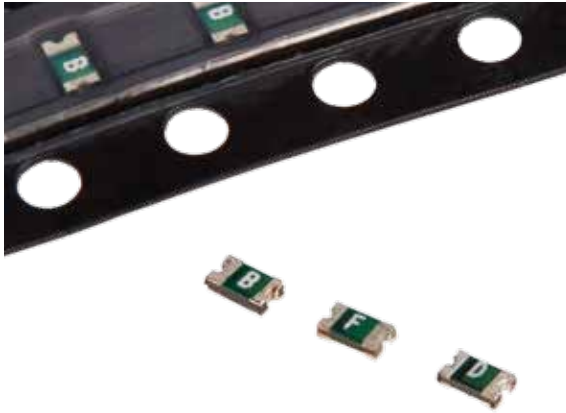

Application

All high-density boards

Product Features

Small surface mountable, Solid state, Faster time to trip than standard SMD devices, Lower resistance than standard SMD devices



Operation Current

0.01A~0.25A

Maximum Voltage

9V~60V_{DC}



Temperature Range

-40°C to 85°C

Agency Recognition

AGENCY	AGENCY FILE NUMBER
	UL(E211981)
	C-UL(E211981)
	TÜV (R50090556)



SVHC Compliant

Electrical Characteristics (23°C)

Part Number	Hold Current	Trip Current	Rated Voltage	Max. Current	Typ. Power	Max. Time to trip		Resistance	
						Current	Time	R _{MIN}	R1 _{MAX}
						I _H , A	I _T , A	V _{MAX} , V _{DC}	I _{MAX} , A
FSMD001-0603-R	0.01	0.03	60	40	0.5	0.20	1.00	15.00	100.00
FSMD002-0603-R	0.02	0.06	60	40	0.5	0.20	1.00	12.00	70.00
FSMD003-0603-R	0.03	0.09	30	40	0.5	0.20	1.00	6.00	50.00
FSMD004-0603-R	0.04	0.12	24	40	0.5	0.20	1.00	4.00	40.00
FSMD005-0603-R	0.05	0.15	15	40	0.5	0.50	0.10	3.80	30.00
FSMD008-0603-R	0.08	0.20	15	40	0.5	0.60	0.10	2.80	14.00
FSMD010-0603-R	0.10	0.25	15	40	0.5	0.70	0.10	0.90	8.00
FSMD012-0603-R	0.12	0.30	9	40	0.5	0.80	0.10	1.10	5.80
FSMD016-0603-R	0.16	0.40	9	40	0.5	1.00	0.10	1.00	4.20
FSMD020-0603-R	0.20	0.45	9	40	0.5	2.00	0.10	0.55	3.50
FSMD025-0603-R	0.25	0.55	9	40	0.5	8.00	0.08	0.50	3.00

Thermal Derating for PPTC Device at Various Ambient Temperatures

TEMPERATURE	-40°C	-20°C	0°C	23°C	30°C	40°C	50°C	60°C	70°C	85°C
DERATING %	157%	137%	118%	100%	89%	80%	70%	60%	51%	37%

Typical Time-To-Trip at 23°C

- A = FSMD001-0603-R
- B = FSMD002-0603-R
- C = FSMD003-0603-R
- D = FSMD004-0603-R
- E = FSMD005-0603-R
- F = FSMD008-0603-R
- G = FSMD010-0603-R
- H = FSMD012-0603-R
- I = FSMD016-0603-R
- J = FSMD020-0603-R
- K = FSMD025-0603-R

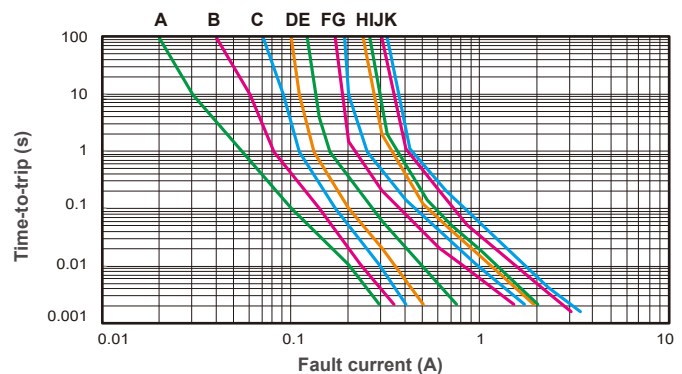

FSMD0603 Product Dimensions (mm)

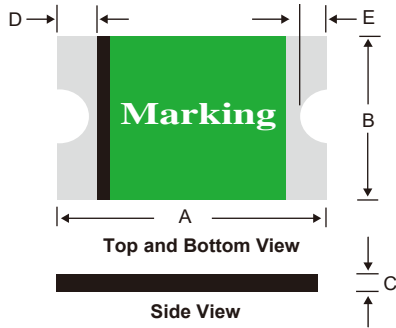

Part Number	A		B		C		D		E	
	Min	Max	Min	Max	Min	Max	Min	Max	Min	Max
FSMD001-0603-R	1.40	1.80	0.45	1.00	0.35	0.85	0.10	0.50	0.08	0.40
FSMD002-0603-R	1.40	1.80	0.45	1.00	0.35	0.85	0.10	0.50	0.08	0.40
FSMD003-0603-R	1.40	1.80	0.45	1.00	0.35	0.75	0.10	0.50	0.08	0.40
FSMD004-0603-R	1.40	1.80	0.45	1.00	0.35	0.75	0.10	0.50	0.08	0.40
FSMD005-0603-R	1.40	1.80	0.45	1.00	0.35	0.75	0.10	0.50	0.08	0.40
FSMD008-0603-R	1.40	1.80	0.45	1.00	0.35	0.75	0.10	0.50	0.08	0.40
FSMD010-0603-R	1.40	1.80	0.45	1.00	0.35	0.75	0.10	0.50	0.08	0.40
FSMD012-0603-R	1.40	1.80	0.45	1.00	0.35	0.75	0.10	0.50	0.08	0.40
FSMD016-0603-R	1.40	1.80	0.45	1.00	0.35	0.75	0.10	0.50	0.08	0.40
FSMD020-0603-R	1.40	1.80	0.45	1.00	0.35	0.75	0.10	0.50	0.08	0.40
FSMD025-0603-R	1.40	1.80	0.45	1.00	0.35	0.75	0.10	0.50	0.08	0.40

*For Reflow Soldering Profile information, please refer to P.80 "IX APPENDIX - SMD PRODUCT SOLDER REFLOW RECOMMENDATIONS"

Part Numbering System

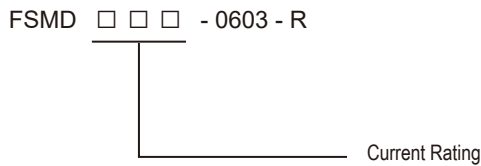

Part Marking System

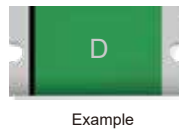

- X = FSMD001-0603-R
- Y = FSMD002-0603-R
- Z = FSMD003-0603-R
- A = FSMD004-0603-R
- B = FSMD005-0603-R
- C = FSMD008-0603-R

- D = FSMD010-0603-R
- E = FSMD012-0603-R
- F = FSMD016-0603-R
- G = FSMD020-0603-R
- V = FSMD025-0603-R

Package Information

Part Number	Standard Package
FSMD001-0603-R-FSMD025-0603-R	: 4.0K Reel/Tape

Physical specifications

Termination pad materials	Pure Tin
Soldering characteristics	Meets EIA specification RS 186-9E, ANSI/J-std-002 Category 3

Warning :



- Each product should be carefully evaluated and tested for their suitability of application.
- Operation beyond the specified maximum ratings or improper use may result in damage and possible electrical arcing and/or flame.
- PPTC device are intended for occasional overcurrent protection. Application for repeated overcurrent condition and/or prolonged trip are not anticipated.
- Avoid contact of PPTC device with chemical solvent, including some inert material such as silicone based oil, lubricant and etc. Prolonged contact will damage the device performance.
- Additional protection mechanism are strongly recommended to be used in conjunction with the PPTC device for protection against abnormal or failure conditions.
- Avoid use of PPTC device in a constrained space such as potting material, housing and containers where have limited space to accommodate device thermal expansion and/or contraction.

FSMD0402 Series



Application

All high-density boards

Product Features

Small surface mountable, Solid state, Faster time to trip than standard SMD devices, Lower resistance than standard SMD devices



Operation Current

0.10A~0.50A

Maximum Voltage

6V_{DC}



Temperature Range

-40°C to 85°C

Agency Recognition

AGENCY	AGENCY FILE NUMBER
	UL(E211981)
	C-UL(E211981)
	TÜV (R50090556)



SVHC Compliant

Electrical Characteristics (23°C)

Part Number	Hold Current	Trip Current	Rated Voltage	Max. Current	Typ. Power	Max. Time to trip		Resistance	
						Current	Time	R _{MIN}	R _{1MAX}
								A	Sec
FSMD010-0402RZ	0.10	0.30	6	100	0.5	1.0	0.150	2.000	
FSMD020-0402RZ	0.20	0.50	6	100	0.5	1.0	0.100	1.250	
FSMD035-0402RZ	0.35	0.70	6	100	0.5	8.0	0.050	0.700	
FSMD050-0402RZ	0.50	1.00	6	100	0.5	8.0	0.040	0.400	

Thermal Derating for PPTC Device at Various Ambient Temperatures

TEMPERATURE	-40°C	-20°C	0°C	23°C	30°C	40°C	50°C	60°C	70°C	85°C
DERATING %	145%	130%	115%	100%	92%	84%	77%	69%	61%	50%

Typical Time-To-Trip at 23°C

- A = FSMD010-0402RZ
- B = FSMD020-0402RZ
- C = FSMD035-0402RZ
- D = FSMD050-0402RZ

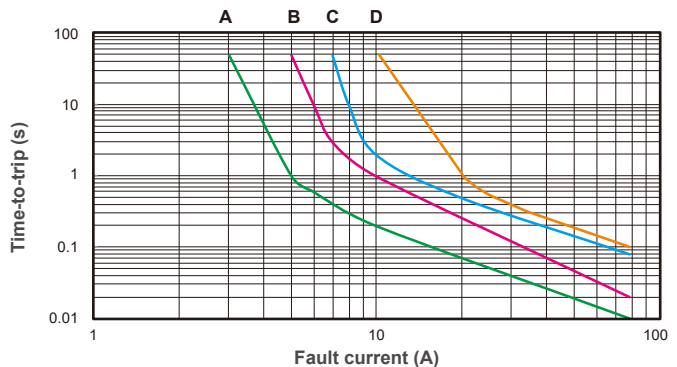

FSMD0402 Product Dimensions (mm)

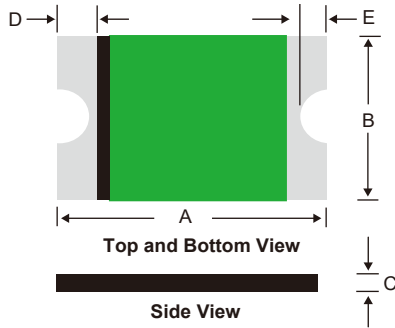

Part Number	A		B		C		D		E	
	Min.	Max.	Min.	Max.	Min.	Max.	Min.	Max.	Min.	Max.
FSMD010-0402RZ	0.85	1.15	0.35	0.65	0.30	0.60	0.10	0.45	0.05	0.40
FSMD020-0402RZ	0.85	1.15	0.35	0.65	0.30	0.60	0.10	0.45	0.05	0.40
FSMD035-0402RZ	0.85	1.15	0.35	0.65	0.30	0.60	0.10	0.45	0.05	0.40
FSMD050-0402RZ	0.85	1.15	0.35	0.65	0.30	0.60	0.10	0.45	0.05	0.40

*For Reflow Soldering Profile information, please refer to P.80 “ IX APPENDIX - SMD PRODUCT SOLDER REFLOW RECOMMENDATIONS ”

Part Numbering System

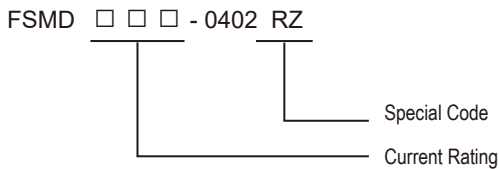

Package Information

Part Number	Standard Package
FSMD010-0402RZ~ FSMD050-0402RZ	10K Reel/Tape

Physical specifications

Termination pad materials	Pure Tin
Soldering characteristics	Meets EIA specification RS 186-9E, ANSI/J-std-002 Category 3

Warning :



- Each product should be carefully evaluated and tested for their suitability of application.
- Operation beyond the specified maximum ratings or improper use may result in damage and possible electrical arcing and/or flame.
- PPTC device are intended for occasional overcurrent protection. Application for repeated overcurrent condition and/or prolonged trip are not anticipated.
- Avoid contact of PPTC device with chemical solvent, including some inert material such as silicone based oil, lubricant and etc. Prolonged contact will damage the device performance.
- Additional protection mechanism are strongly recommended to be used in conjunction with the PPTC device for protection against abnormal or failure conditions.
- Avoid use of PPTC device in a constrained space such as potting material, housing and containers where have limited space to accommodate device thermal expansion and/or contraction.
- Avoid PPTC devices being exposed to prolonged high temperature and/or high humidity storage environment such as 85°C and/or 85RH% which could diminish PPTC's performance.

FSMD0201 Series

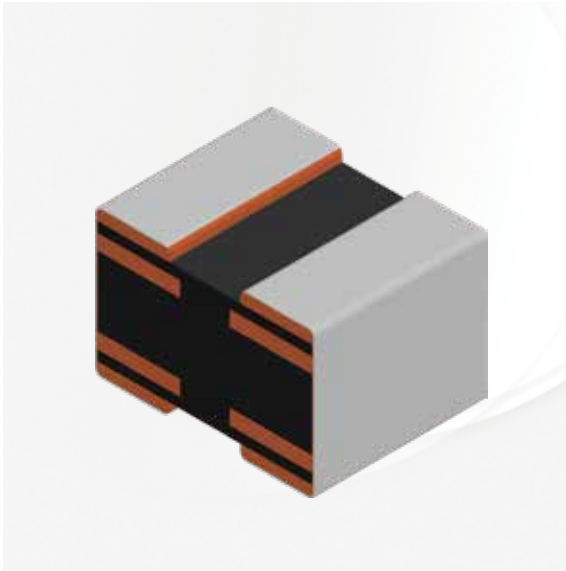

Application

All high-density boards

Product Features

Small surface mountable, Solid state, Faster time to trip than standard SMD devices, Lower resistance than standard SMD devices



Operation Current

0.011~0.025A

Maximum Voltage

6~13V



Temperature Range

-40°C to 85°C

Agency Recognition

AGENCY	AGENCY FILE NUMBER
	UL(E211981)
	C-UL(E211981)
	TÜV (R50090556)



SVHC Compliant

Electrical Characteristics (23°C)

Part Number	Hold Current	Trip Current	Rated Voltage	Max. Current	Typ. Power	Max. Time to trip		Resistance	
	I_H , A	I_T , A	V_{MAX} , V _{DC}	I_{MAX} , A	P_d , W	Current	Time	R_{MIN}	$R1_{MAX}$
						A	Sec	Ohms	Ohms
FSMD0011-0201	0.011	0.055	13	0.082	0.125	0.080	0.02	10	290
FSMD0015-0201	0.015	0.075	13	0.200	0.125	0.080	0.02	10	150
FSMD0025-0201	0.025	0.125	6	0.500	0.125	0.125	3.00	2	50

Thermal Derating for PPTC Device at Various Ambient Temperatures

TEMPERATURE	-40°C	-20°C	0°C	23°C	30°C	40°C	50°C	60°C	70°C	85°C
DERATING %	157%	137%	118%	100%	89%	80%	70%	60%	51%	37%

Typical Time-To-Trip at 23°C

- A = FSMD0011-0201
- B = FSMD0015-0201
- C = FSMD0025-0201

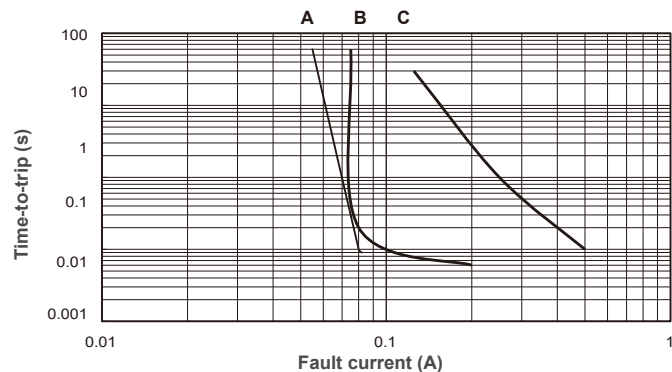

FSMD0201 Product Dimensions (mm)

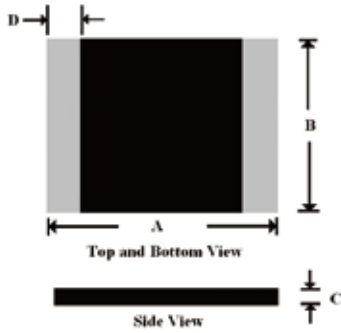

Part Number	A		B		C		D	
	Min	Max	Min	Max	Min	Max	Min	Max
FSMD0011-0201	0.55	0.65	0.40	0.55	0.30	0.70	0.10	0.25
FSMD0015-0201	0.55	0.65	0.40	0.55	0.30	0.70	0.10	0.25
FSMD0025-0201	0.55	0.65	0.40	0.55	0.30	0.70	0.10	0.25

*For Reflow Soldering Profile information, please refer to P.81 “ IX APPENDIX - SMD PRODUCT SOLDER REFLOW RECOMMENDATIONS ”

Part Numbering System

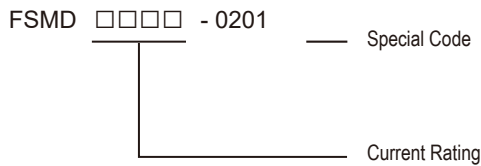

Physical specifications

Termination pad materials	Pure Tin
Soldering characteristics	Meets EIA specification RS 186-9E, ANSI/J-std-002 Category 3

Warning :



- Each product should be carefully evaluated and tested for their suitability of application.
- Operation beyond the specified maximum ratings or improper use may result in damage and possible electrical arcing and/or flame.
- PPTC device are intended for occasional overcurrent protection. Application for repeated overcurrent condition and/or prolonged trip are not anticipated.
- Avoid contact of PPTC device with chemical solvent, including some inert material such as silicone based oil, lubricant and etc. Prolonged contact will damage the device performance.
- Additional protection mechanism are strongly recommended to be used in conjunction with the PPTC device for protection against abnormal or failure conditions.
- Avoid use of PPTC device in a constrained space such as potting material, housing and containers where have limited space to accommodate device thermal expansion and/or contraction.



FUZETEC

Package Size: 1206 - 0402

Current Rating: Up to 6A

Voltage Rating: 6 - 9V

Low Rho
SMD PPTC
Series

Low Rho FSMD1206 Series



Application

All high-density boards

Product Features

Small surface mountable, Solid state, Faster time to trip than standard SMD devices, Lower resistance than standard SMD devices



Operation Current

0.50A~5.00A

Maximum Voltage

6V_{DC}



Temperature Range

-40°C to 85°C

Agency Recognition

AGENCY	AGENCY FILE NUMBER
	UL(E211981)
	C-UL(E211981)
	TÜV (R50090556)



SVHC Compliant

Electrical Characteristics (23°C)

Part Number	Hold Current	Trip Current	Rated Voltage	Max. Current	Typ. Power	Max. Time to trip		Resistance	
						Current	Time	R _{MIN}	R _{1MAX}
						I _H , A	I _T , A	V _{MAX} , V _{DC}	I _{MAX} , A
FSMD050-1206RZ	0.50	1.50	6	100	0.8	8.0	0.20	0.025	0.200
FSMD075-1206RZ	0.75	1.80	6	100	0.8	8.0	0.30	0.018	0.180
FSMD110-1206RZ	1.10	2.20	6	100	0.8	8.0	0.30	0.015	0.100
FSMD150-1206RZ	1.50	3.00	6	100	0.8	8.0	0.30	0.010	0.065
FSMD175-1206RZ	1.75	3.50	6	100	0.8	8.0	0.40	0.005	0.030
FSMD200-1206RZ	2.00	4.00	6	100	0.8	8.0	0.50	0.005	0.025
FSMD260-1206RZ	2.60	5.20	6	100	0.8	8.0	4.00	0.003	0.025
FSMD300-1206RZ	3.00	6.00	6	100	0.8	8.0	4.00	0.003	0.020
FSMD350-1206RZ	3.50	7.00	6	100	0.8	8.0	5.00	0.003	0.018
FSMD380-1206RZ	3.80	8.00	6	100	0.8	8.0	5.00	0.002	0.014
FSMD400-1206RZ	4.00	8.00	6	100	0.8	8.0	5.00	0.002	0.014
FSMD450-1206RZ	4.50	9.00	6	100	0.8	22.5	2.00	0.001	0.014
FSMD500-1206RZ	5.00	10.00	6	100	0.8	25.0	5.00	0.001	0.012

Thermal Derating for PPTC Device at Various Ambient Temperatures

TEMPERATURE	-40°C	-20	0°C	23°C	30°C	40°C	50°C	60°C	70°C	85°C
DERATING %	145%	130%	115%	100%	92%	84%	77%	69%	61%	50%

Typical Time-To-Trip at 23°C

- A = FSMD050-1206RZ H = FSMD300-1206RZ
- B = FSMD075-1206RZ I = FSMD350-1206RZ
- C = FSMD110-1206RZ J = FSMD380-1206RZ
- D = FSMD150-1206RZ K = FSMD400-1206RZ
- E = FSMD175-1206RZ L = FSMD450-1206RZ
- F = FSMD200-1206RZ M = FSMD500-1206RZ
- G = FSMD260-1206RZ

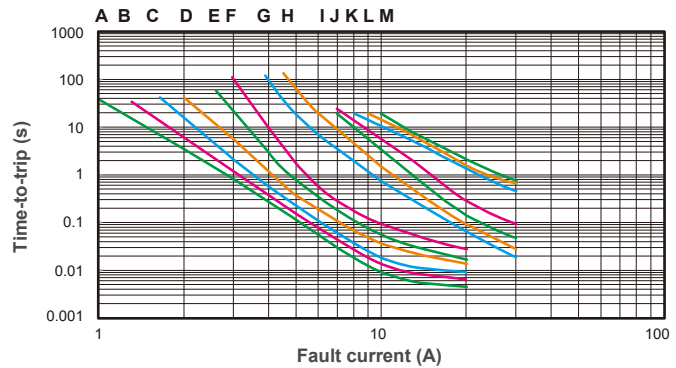

Low Rho FSMD1206 Product Dimensions (mm)

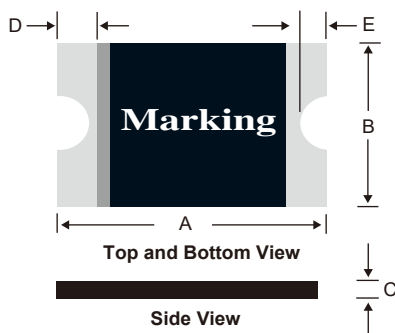

*For Reflow Soldering Profile information, please refer to P.80 " IX APPENDIX - SMD PRODUCT SOLDER REFLOW RECOMMENDATIONS "

Part Number	A		B		C		D		E	
	Min.	Max.	Min.	Max.	Min.	Max.	Min.	Max.	Min.	Max.
FSMD050-1206RZ	3.00	3.50	1.50	1.80	0.30	0.70	0.25	0.75	0.10	0.45
FSMD075-1206RZ	3.00	3.50	1.50	1.80	0.30	0.70	0.25	0.75	0.10	0.45
FSMD110-1206RZ	3.00	3.50	1.50	1.80	0.30	0.70	0.25	0.75	0.10	0.45
FSMD150-1206RZ	3.00	3.50	1.50	1.80	0.30	0.70	0.25	0.75	0.10	0.45
FSMD175-1206RZ	3.00	3.50	1.50	1.80	0.30	0.70	0.25	0.75	0.10	0.45
FSMD200-1206RZ	3.00	3.50	1.50	1.80	0.30	0.70	0.25	0.75	0.10	0.45
FSMD260-1206RZ	3.00	3.50	1.50	1.80	0.30	1.00	0.25	0.75	0.10	0.45
FSMD300-1206RZ	3.00	3.50	1.50	1.80	0.30	1.00	0.25	0.75	0.10	0.45
FSMD350-1206RZ	3.00	3.50	1.50	1.80	0.60	1.00	0.25	0.75	0.10	0.45
FSMD380-1206RZ	3.00	3.50	1.50	1.80	0.60	1.00	0.25	0.75	0.10	0.45
FSMD400-1206RZ	3.00	3.50	1.50	1.80	0.60	1.00	0.25	0.75	0.10	0.45
FSMD450-1206RZ	3.00	3.50	1.50	1.80	0.60	1.00	0.25	0.75	0.10	0.45
FSMD500-1206RZ	3.00	3.50	1.50	1.80	0.60	1.00	0.25	0.75	0.10	0.45

Part Numbering System

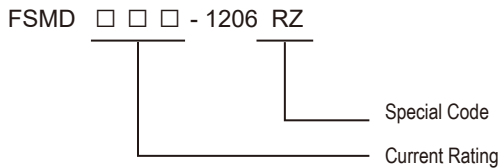

Part Marking System

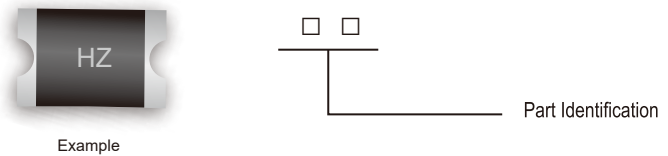

- EZ = FSMD050-1206RZ SZ = FSMD300-1206RZ
- FZ = FSMD075-1206RZ VZ = FSMD350-1206RZ
- HZ = FSMD110-1206RZ WZ = FSMD380-1206RZ
- JZ = FSMD150-1206RZ XZ = FSMD400-1206RZ
- KZ = FSMD175-1206RZ YZ = FSMD450-1206RZ
- MZ = FSMD200-1206RZ ZZ = FSMD500-1206RZ
- QZ = FSMD260-1206RZ

Package Information

Part Number	Standard Package
FSMD050-1206RZ~ FSMD200-1206RZ	: 4.0K Reel/Tape
FSMD260-1206RZ~ FSMD500-1206RZ	: 3.0K Reel/Tape

Physical specifications

Termination pad materials	Pure Tin
Soldering characteristics	Meets EIA specification RS 186-9E, ANSI/J-std-002 Category 3



- Warning :**
- Each product should be carefully evaluated and tested for their suitability of application.
 - Operation beyond the specified maximum ratings or improper use may result in damage and possible electrical arcing and/or flame.
 - PPTC device are intended for occasional overcurrent protection. Application for repeated overcurrent condition and/or prolonged trip are not anticipated.
 - Avoid contact of PPTC device with chemical solvent, including some inert material such as silicone based oil, lubricant and etc. Prolonged contact will damage the device performance.
 - Additional protection mechanism are strongly recommended to be used in conjunction with the PPTC device for protection against abnormal or failure conditions.
 - Avoid use of PPTC device in a constrained space such as potting material, housing and containers where have limited space to accommodate device thermal expansion and/or contraction.
 - Avoid PPTC devices being exposed to prolonged high temperature and/or high humidity storage environment such as 85°C and/or 85RH% which could diminish PPTC's performance.

Low Rho FSMD0805 Series



Application

All high-density boards

Product Features

Small surface mountable, Solid state, Faster time to trip than standard SMD devices, Lower resistance than standard SMD devices



Operation Current

0.75A~3.50A

Maximum Voltage

6V_{DC}



Temperature Range

-40°C to 85°C

Agency Recognition

AGENCY	AGENCY FILE NUMBER
	UL(E211981)
	C-UL(E211981)
	TÜV (R50090556)



SVHC Compliant

Electrical Characteristics (23°C)

Part Number	Hold Current	Trip Current	Rated Voltage	Max. Current	Typ. Power	Max. Time to trip		Resistance	
						Current	Time	R _{MIN}	R _{1MAX}
						I _H , A	I _T , A	V _{MAX} , V _{DC}	I _{MAX} , A
FSMD075-0805RZ	0.75	1.50	6	100	0.6	8.0	0.20	0.040	0.160
FSMD110-0805RZ	1.10	1.80	6	100	0.6	8.0	0.30	0.030	0.130
FSMD125-0805RZ	1.25	2.50	6	100	0.6	8.0	0.30	0.025	0.110
FSMD150-0805RZ	1.50	3.00	6	100	0.6	8.0	0.30	0.015	0.065
FSMD175-0805RZ	1.75	3.50	6	100	0.6	8.0	0.60	0.005	0.055
FSMD200-0805RZ	2.00	4.00	6	100	0.6	8.0	1.00	0.005	0.045
FSMD300-0805RZ	3.00	6.00	6	100	0.6	8.0	5.00	0.003	0.030
FSMD350-0805RZ	3.50	7.00	6	100	0.6	8.0	5.00	0.002	0.025

Thermal Derating for PPTC Device at Various Ambient Temperatures

TEMPERATURE	-40°C	-20°C	0°C	23°C	30°C	40°C	50°C	60°C	70°C	85°C
DERATING %	145%	130%	115%	100%	92%	84%	77%	69%	61%	50%

Typical Time-To-Trip at 23°C

- A = FSMD075-0805RZ
- B = FSMD110-0805RZ
- C = FSMD125-0805RZ
- D = FSMD150-0805RZ
- E = FSMD175-0805RZ
- F = FSMD200-0805RZ
- G = FSMD300-0805RZ
- H = FSMD350-0805RZ

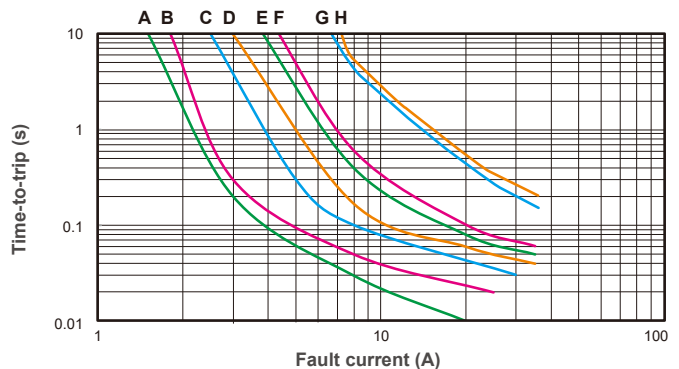

Low Rho FSMD0805 Product Dimensions (mm)

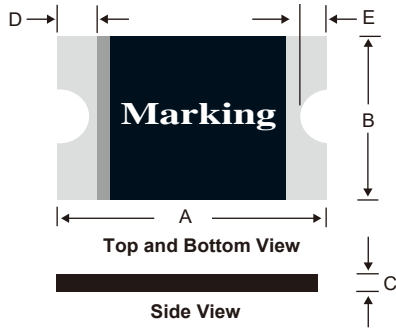

Part Number	A		B		C		D		E	
	Min.	Max.	Min.	Max.	Min.	Max.	Min.	Max.	Min.	Max.
FSMD075-0805RZ	2.00	2.20	1.20	1.50	0.30	0.70	0.20	0.60	0.10	0.45
FSMD110-0805RZ	2.00	2.20	1.20	1.50	0.30	0.70	0.20	0.60	0.10	0.45
FSMD125-0805RZ	2.00	2.20	1.20	1.50	0.30	0.70	0.20	0.60	0.10	0.45
FSMD150-0805RZ	2.00	2.20	1.20	1.50	0.30	0.70	0.20	0.60	0.10	0.45
FSMD175-0805RZ	2.00	2.20	1.20	1.50	0.30	0.70	0.20	0.60	0.10	0.45
FSMD200-0805RZ	2.00	2.20	1.20	1.50	0.30	1.00	0.20	0.60	0.10	0.45
FSMD300-0805RZ	2.00	2.20	1.20	1.50	0.60	1.40	0.20	0.60	0.10	0.45
FSMD350-0805RZ	2.00	2.20	1.20	1.50	0.60	1.40	0.20	0.60	0.10	0.45

*For Reflow Soldering Profile information, please refer to P.80 "IX APPENDIX - SMD PRODUCT SOLDER REFLOW RECOMMENDATIONS"

Part Numbering System

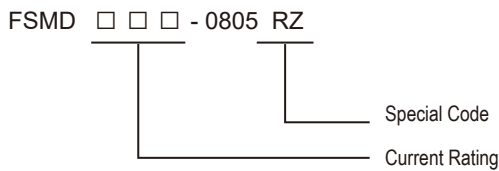

Part Marking System

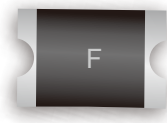

Example



- F = FSMD075-0805RZ
- H = FSMD110-0805RZ
- I = FSMD125-0805RZ
- J = FSMD150-0805RZ

- K = FSMD175-0805RZ
- M = FSMD200-0805RZ
- S = FSMD300-0805RZ
- V = FSMD350-0805RZ

Package Information

Part Number	Standard Package
FSMD075-0805RZ~ FSMD175-0805RZ	: 4.0K Reel/Tape
FSMD200-0805RZ~ FSMD350-0805RZ	: 3.0K Reel/Tape

Physical specifications

Termination pad materials	Pure Tin
Soldering characteristics	Meets EIA specification RS 186-9E, ANSI/J-std-002 Category 3

Warning :



- Each product should be carefully evaluated and tested for their suitability of application.
- Operation beyond the specified maximum ratings or improper use may result in damage and possible electrical arcing and/or flame.
- PPTC device are intended for occasional overcurrent protection. Application for repeated overcurrent condition and/or prolonged trip are not anticipated.
- Avoid contact of PPTC device with chemical solvent, including some inert material such as silicone based oil, lubricant and etc. Prolonged contact will damage the device performance.
- Additional protection mechanism are strongly recommended to be used in conjunction with the PPTC device for protection against abnormal or failure conditions.
- Avoid use of PPTC device in a constrained space such as potting material, housing and containers where have limited space to accommodate device thermal expansion and/or contraction.
- Avoid PPTC devices being exposed to prolonged high temperature and/or high humidity storage environment such as 85°C and/or 85RH% which could diminish PPTC's performance.

Low Rho FSMD0603 Series



Application

All high-density boards

Product Features

Small surface mountable, Solid state, Faster time to trip than standard SMD devices, Lower resistance than standard SMD devices



Operation Current

0.25A~1.00A

Maximum Voltage

6V~9V_{DC}



Temperature Range

-40°C to 85°C

Agency Recognition

AGENCY	AGENCY FILE NUMBER
	UL(E211981)
	C-UL(E211981)
	TÜV (R50090556)



SVHC Compliant

Electrical Characteristics (23°C)

Part Number	Hold Current	Trip Current	Rated Voltage	Max. Current	Typ. Power	Max. Time to trip		Resistance	
						Current	Time	R _{MIN}	R _{1MAX}
								A	Sec
FSMD025-0603RZ	0.25	0.55	9	100	0.5	8.0	0.08	0.500	3.000
FSMD035-0603RZ	0.35	0.75	6	100	0.5	8.0	0.10	0.200	1.000
FSMD050-0603RZ	0.50	1.00	6	100	0.6	8.0	0.10	0.070	0.350
FSMD075-0603RZ	0.75	1.50	6	100	0.6	8.0	0.20	0.050	0.250
FSMD100-0603RZ	1.00	1.80	6	100	0.6	8.0	0.30	0.040	0.120

Thermal Derating for PPTC Device at Various Ambient Temperatures

TEMPERATURE	-40°C	-20°C	0°C	23°C	30°C	40°C	50°C	60°C	70°C	85°C
DERATING %	145%	130%	115%	100%	92%	84%	77%	69%	61%	50%

Typical Time-To-Trip at 23°C

- A = FSMD025-0603RZ
- B = FSMD035-0603RZ
- C = FSMD050-0603RZ
- D = FSMD075-0603RZ
- E = FSMD100-0603RZ

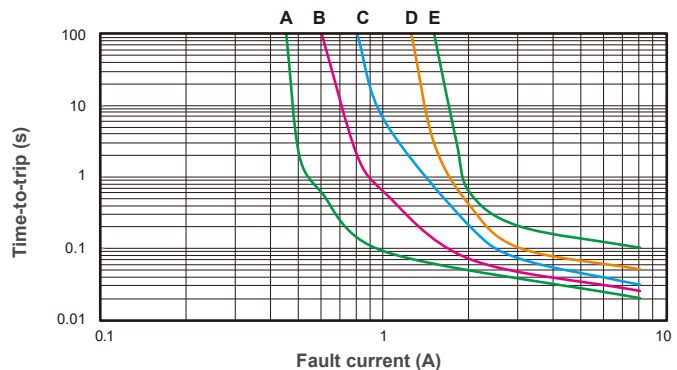

Low Rho FSMD0603 Product Dimensions (mm)

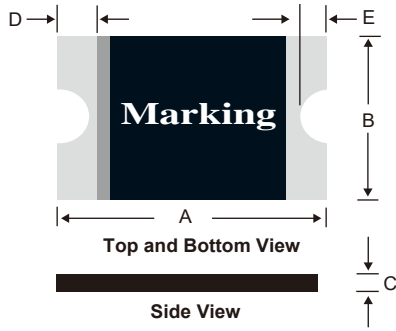

Part Number	A		B		C		D		E	
	Min.	Max.	Min.	Max.	Min.	Max.	Min.	Max.	Min.	Max.
FSMD025-0603RZ	1.40	1.80	0.45	1.00	0.30	0.70	0.10	0.50	0.08	0.40
FSMD035-0603RZ	1.40	1.80	0.45	1.00	0.30	0.70	0.10	0.50	0.08	0.40
FSMD050-0603RZ	1.40	1.80	0.45	1.00	0.30	0.70	0.10	0.50	0.08	0.40
FSMD075-0603RZ	1.40	1.80	0.45	1.00	0.30	0.70	0.10	0.50	0.08	0.40
FSMD100-0603RZ	1.40	1.80	0.45	1.00	0.30	0.70	0.10	0.50	0.08	0.40

*For Reflow Soldering Profile information, please refer to P.80 "IX APPENDIX - SMD PRODUCT SOLDER REFLOW RECOMMENDATIONS"

Part Numbering System

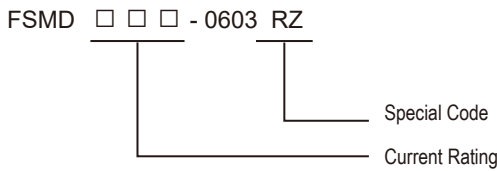

Part Marking System

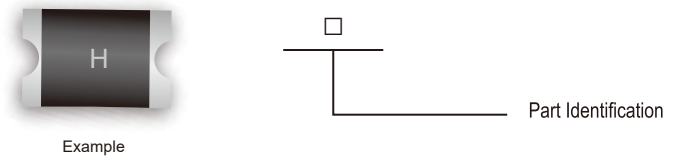

- H = FSMD025-0603RZ
- I = FSMD035-0603RZ
- J = FSMD050-0603RZ
- K = FSMD075-0603RZ
- L = FSMD100-0603RZ

Package Information

Part Number	Standard Package
FSMD025-0603RZ~ FSMD100-0603RZ	4.0K Reel/Tape

Physical specifications

Termination pad materials	Pure Tin
Soldering characteristics	Meets EIA specification RS 186-9E, ANSI/J-std-002 Category 3

Warning :



- Each product should be carefully evaluated and tested for their suitability of application.
- Operation beyond the specified maximum ratings or improper use may result in damage and possible electrical arcing and/or flame.
- PPTC device are intended for occasional overcurrent protection. Application for repeated overcurrent condition and/or prolonged trip are not anticipated.
- Avoid contact of PPTC device with chemical solvent, including some inert material such as silicone based oil, lubricant and etc. Prolonged contact will damage the device performance.
- Additional protection mechanism are strongly recommended to be used in conjunction with the PPTC device for protection against abnormal or failure conditions.
- Avoid use of PPTC device in a constrained space such as potting material, housing and containers where have limited space to accommodate device thermal expansion and/or contraction.
- Avoid PPTC devices being exposed to prolonged high temperature and/or high humidity storage environment such as 85°C and/or 85RH% which could diminish PPTC's performance.

Low Rho FSMD0402 Series



Application

All high-density boards

Product Features

Small surface mountable, Solid state, Faster time to trip than standard SMD devices, Lower resistance than standard SMD devices



Operation Current

0.10A~0.50A

Maximum Voltage

6V_{DC}



Temperature Range

-40°C to 85°C

Agency Recognition

AGENCY	AGENCY FILE NUMBER
	UL(E211981)
	C-UL(E211981)
	TÜV (R50090556)



SVHC Compliant

Electrical Characteristics (23°C)

Part Number	Hold Current I _H , A	Trip Current I _T , A	Rated Voltage V _{MAX} , V _{DC}	Max. Current I _{MAX} , A	Typ. Power Pd, W	Max. Time to trip		Resistance	
						Current	Time	R _{MIN}	R _{1MAX}
						A	Sec	Ohms	Ohms
FSMD010-0402RZ	0.10	0.30	6	100	0.5	0.5	1.0	0.150	2.000
FSMD020-0402RZ	0.20	0.50	6	100	0.5	1.0	1.0	0.100	1.250
FSMD035-0402RZ	0.35	0.70	6	100	0.5	8.0	0.1	0.050	0.700
FSMD050-0402RZ	0.50	1.00	6	100	0.5	8.0	0.1	0.040	0.400

Thermal Derating for PPTC Device at Various Ambient Temperatures

TEMPERATURE	-40°C	-20°C	0°C	23°C	30°C	40°C	50°C	60°C	70°C	85°C
DERATING %	145%	130%	115%	100%	92%	84%	77%	69%	61%	50%

Typical Time-To-Trip at 23°C

- A = FSMD010-0402RZ
- B = FSMD020-0402RZ
- C = FSMD035-0402RZ
- D = FSMD050-0402RZ

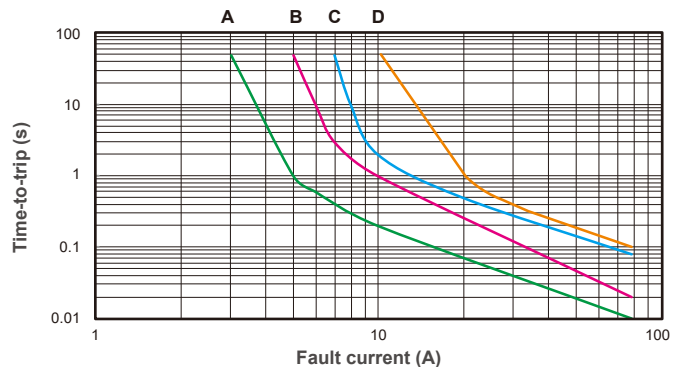

Low Rho FSMD0402 Product Dimensions (mm)

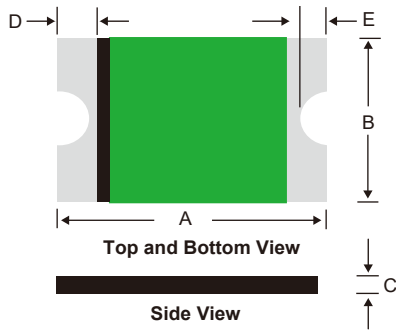

Part Number	A		B		C		D		E	
	Min.	Max.	Min.	Max.	Min.	Max.	Min.	Max.	Min.	Max.
FSMD010-0402RZ	0.85	1.15	0.35	0.65	0.30	0.60	0.10	0.45	0.05	0.40
FSMD020-0402RZ	0.85	1.15	0.35	0.65	0.30	0.60	0.10	0.45	0.05	0.40
FSMD035-0402RZ	0.85	1.15	0.35	0.65	0.30	0.60	0.10	0.45	0.05	0.40
FSMD050-0402RZ	0.85	1.15	0.35	0.65	0.30	0.60	0.10	0.45	0.05	0.40

*For Reflow Soldering Profile information, please refer to P.80 “ IX APPENDIX - SMD PRODUCT SOLDER REFLOW RECOMMENDATIONS ”

Part Numbering System

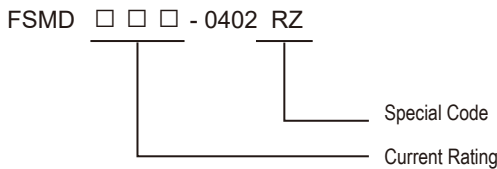

Package Information

Part Number	Standard Package
FSMD010-0402RZ~ FSMD050-0402RZ	10K Reel/Tape

Physical specifications

Termination pad materials	Pure Tin
Soldering characteristics	Meets EIA specification RS 186-9E, ANSI/J-std-002 Category 3

Warning :



- Each product should be carefully evaluated and tested for their suitability of application.
- Operation beyond the specified maximum ratings or improper use may result in damage and possible electrical arcing and/or flame.
- PPTC device are intended for occasional overcurrent protection. Application for repeated overcurrent condition and/or prolonged trip are not anticipated.
- Avoid contact of PPTC device with chemical solvent, including some inert material such as silicone based oil, lubricant and etc. Prolonged contact will damage the device performance.
- Additional protection mechanism are strongly recommended to be used in conjunction with the PPTC device for protection against abnormal or failure conditions.
- Avoid use of PPTC device in a constrained space such as potting material, housing and containers where have limited space to accommodate device thermal expansion and/or contraction.
- Avoid PPTC devices being exposed to prolonged high temperature and/or high humidity storage environment such as 85°C and/or 85RH% which could diminish PPTC's performance.

STRAP Series

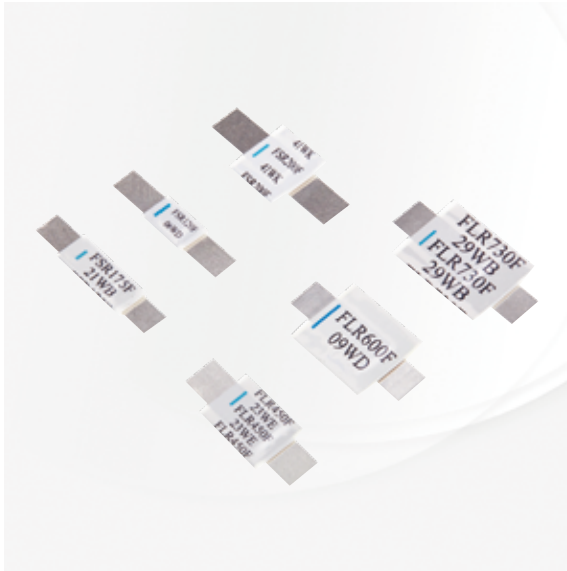

Application

Rechargeable battery packs, Lithium cell and battery packs

Product Features

Low profile, Solid state



Operation Current

FLR Series 1.90A~9.00A ; FSR Series 1.20A~4.20A

Maximum Voltage

15V ~ 30V_{DC}



Temperature Range

-40°C to 85°C

Agency Recognition

AGENCY	AGENCY FILE NUMBER
	UL(E211981)
	C-UL(E211981)
	TÜV (R50004084)



SVHC Compliant

Electrical Characteristics (23°C)

Part Number	Hold Current	Trip Current	Max. Time to trip	Rated Voltage	Max. Current	Typ. Power	Resistance		
	I_H , A	I_T , A	at $5xI_H$, S	V_{MAX} , V _{DC}	I_{MAX} , A	P_d , W	R_{MIN}	R_{MAX}	$R1_{MAX}$
							Ohms	Ohms	Ohms
FSR120F	1.20	2.70	5.0	15	100	1.2	0.085	0.160	0.220
FSR175F	1.75	3.80	5.0	15	100	1.5	0.050	0.090	0.120
FSR200F	2.00	4.40	4.0	30	100	1.9	0.030	0.060	0.100
FSR350F	3.50	6.30	3.0	30	100	2.5	0.017	0.031	0.050
FSR420F	4.20	7.60	6.0	30	100	2.9	0.012	0.024	0.040
FLR190F	1.90	3.90	5.0	15	100	1.2	0.039	0.072	0.102
FLR260F	2.60	5.80	5.0	15	100	2.5	0.020	0.042	0.063
FLR380F	3.80	8.30	5.0	15	100	2.5	0.013	0.026	0.037
FLR450F	4.50	8.90	5.0	20	100	2.5	0.011	0.020	0.028
FLR550F	5.50	10.50	5.0	20	100	2.8	0.009	0.016	0.022
FLR600F	6.00	11.70	5.0	20	100	2.8	0.007	0.014	0.019
FLR730F	7.30	14.10	5.0	20	100	3.3	0.006	0.012	0.015
FLR900F	9.00	16.70	5.0	20	100	3.8	0.006	0.010	0.014

Thermal Derating for PPTC Device at Various Ambient Temperatures

TEMPERATURE	-40°C	-20°C	0°C	23°C	30°C	40°C	50°C	60°C	70°C	85°C
FSR Series	152%	135%	118%	100%	90%	82%	74%	65%	56%	42%
FLR Series	147%	132%	117%	100%	94%	86%	80%	71%	61%	52%

Typical Time-To-Trip at 23°C

FSR Series

- A = FSR120F
- B = FSR175F
- C = FSR200F
- D = FSR350F
- E = FSR420F

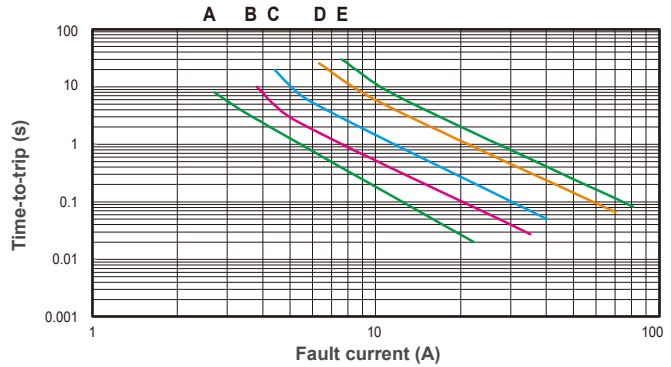

FLR Series

- A = FLR190F
- B = FLR260F
- C = FLR380F
- D = FLR450F
- E = FLR550F
- F = FLR600F
- G = FLR730F
- H = FLR900F

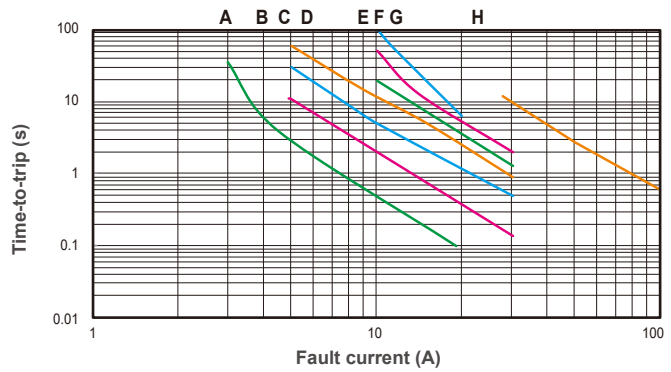

Product Dimensions (mm)

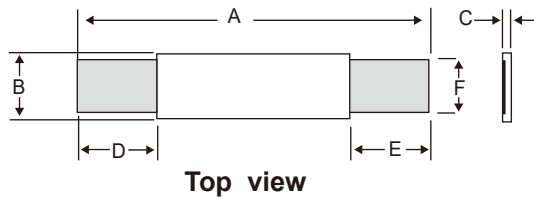

Part Number	A		B		C		D		E		F	
	Min.	Max.	Min.	Max.	Min.	Max.	Min.	Max.	Min.	Max.	Min.	Max.
FSR120F	19.9	22.1	4.9	5.2	0.6	1.0	5.5	7.5	5.5	7.5	3.9	4.1
FSR175F	20.9	23.1	4.9	5.2	0.6	1.0	4.1	5.5	4.1	5.5	3.9	4.1
FSR200F	21.3	23.4	10.2	11.0	0.5	1.1	5.0	7.6	5.0	7.6	4.8	5.4
FSR350F	28.4	31.8	13.0	13.5	0.5	1.1	6.3	8.9	6.3	8.9	5.9	6.1
FSR420F	30.6	32.4	12.9	13.6	0.5	1.1	5.0	7.5	5.0	7.5	5.9	6.1
FLR190F	19.9	22.1	4.9	5.5	0.6	1.0	5.5	7.5	5.5	7.5	3.9	4.1
FLR260F	20.9	23.1	4.9	5.5	0.6	1.0	4.1	5.5	4.1	5.5	3.9	4.1
FLR380F	24.0	26.0	6.9	7.5	0.6	1.0	4.1	5.5	4.1	5.5	4.9	5.1
FLR450F	24.0	26.0	9.9	10.5	0.6	1.0	5.3	6.7	5.3	6.7	5.9	6.1
FLR550F	35.0	37.0	6.9	7.5	0.6	1.0	5.3	6.7	5.3	6.7	4.9	5.1
FLR600F	24.0	26.0	13.9	14.5	0.6	1.0	4.1	5.5	4.1	5.5	5.9	6.1
FLR730F	27.1	29.1	13.9	14.5	0.6	1.0	4.1	5.5	4.1	5.5	5.9	6.1
FLR900F	45.4	47.6	7.9	8.5	0.6	1.3	5.2	7.9	5.2	7.9	5.9	6.1

Part Numbering System

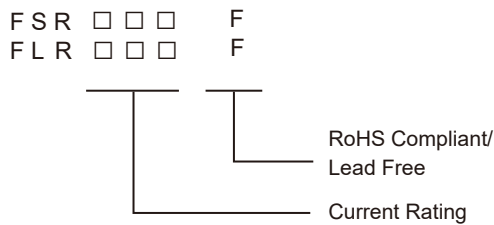

Part Marking System

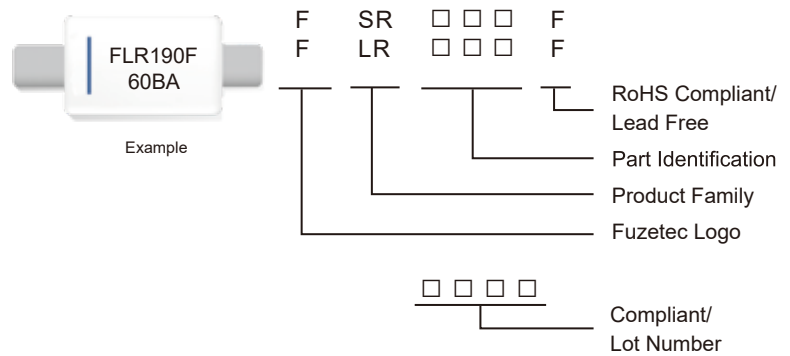

Package Information

Part Number		Standard Package
FSR120F~FSR175F	:	1.0K Pcs/Bag
FSR200F~FSR420F	:	500 Pcs/Bag
FLR190F~FLR380F	:	1.0K Pcs/Bag
FLR450F~FLR900F	:	500 Pcs/Bag

Physical specifications

Lead material	0.13mm nominal thickness, quarter-hard nickel.
Insulating coating	Polyester tape.

Warning :



- Each product should be carefully evaluated and tested for their suitability of application.
- Operation beyond the specified maximum ratings or improper use may result in damage and possible electrical arcing and/or flame.
- PPTC device are intended for occasional overcurrent protection. Application for repeated overcurrent condition and/or prolonged trip are not anticipated.
- Avoid contact of PPTC device with chemical solvent, including some inert material such as silicone based oil, lubricant and etc. Prolonged contact will damage the device performance.
- Additional protection mechanism are strongly recommended to be used in conjunction with the PPTC device for protection against abnormal or failure conditions.
- Avoid use of PPTC device in a constrained space such as potting material, housing and containers where have limited space to accommodate device thermal expansion and/or contraction.



FUZETEC

Dip & SMD Package

Temperature Range: -40°C to 125°C

ideal for industrial and automotive
application



High
Temperature
PPTC

FHT Series

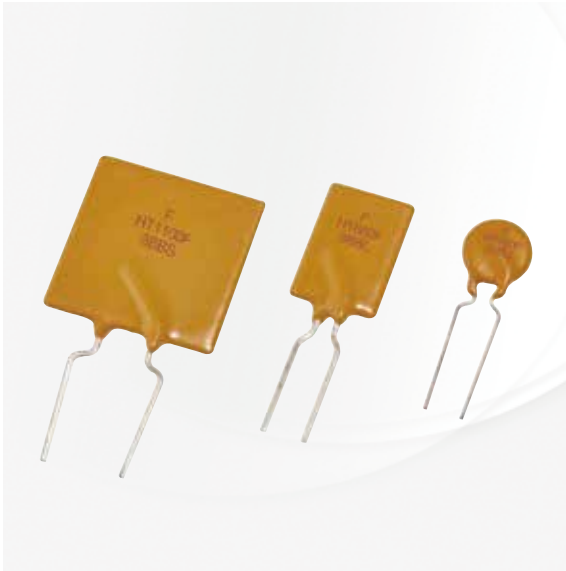

Application

Wide variety of electronic equipment

Product Features

Very Low resistance, Very High hold current, Solid state, Radial leaded product ideal for up to 16V/30V_{DC} and operating temperatures up to 125°C.



Operation Current

0.50A~15.00A

Maximum Voltage

16V/30V_{DC}



Temperature Range

-40°C to 125°C

Agency Recognition

AGENCY	AGENCY FILE NUMBER
	UL(E211981)
	C-UL(E211981)
	TÜV (R50004084)



Electrical Characteristics (23°C)

Part Number	Hold Current I _H , A	Trip Current I _T , A	Max. Time to trip at 5xI _H , s	Max. Current I _{MAX} , A	Rated Voltage V _{MAX} , V _{DC}	Typ. Power Pd, W	Resistance	
							R _{MIN} Ohms	R _{1MAX} Ohms
FHT050-30F	0.5	0.9	2.5	40	30	0.9	0.4800	1.1000
FHT070-30F	0.7	1.4	3.2	40	30	1.4	0.3000	0.8000
FHT100-30F	1.0	1.8	5.2	40	30	1.4	0.1800	0.4300
FHT200-16F	2.0	3.8	3.0	100	16	1.4	0.0450	0.1100
FHT300-16F	3.0	6.0	5.0	100	16	3.0	0.0330	0.0790
FHT400-16F	4.0	7.0	5.0	100	16	3.3	0.0240	0.0600
FHT450-16F	4.5	7.8	3.0	100	16	3.6	0.0220	0.0540
FHT550-16F	5.5	10.0	6.0	100	16	3.5	0.0150	0.0370
FHT600-16F	6.0	10.8	5.0	100	16	4.1	0.0130	0.0320
FHT650-16F	6.5	12.0	5.5	100	16	4.3	0.0110	0.0260
FHT700-16F	7.0	13.0	7.0	100	16	4.0	0.0100	0.0250
FHT750-16F	7.5	13.1	7.0	100	16	4.5	0.0094	0.0220
FHT800-16F	8.0	15.0	8.0	100	16	4.2	0.0080	0.0200
FHT900-16F	9.0	16.5	10.0	100	16	5.0	0.0074	0.0170
FHT1000-16F	10.0	18.5	9.0	100	16	5.3	0.0062	0.0150
FHT1100-16F	11.0	20.0	11.0	100	16	5.5	0.0055	0.0130
FHT1300-16F	13.0	24.0	13.0	100	16	6.9	0.0041	0.0100
FHT1400-16F	14.0	27.0	13.0	100	16	6.9	0.0030	0.0090
FHT1500-16F	15.0	28.0	20.0	100	16	7.0	0.0032	0.0092

Thermal Derating for PPTC Device at Various Ambient Temperatures

TEMPERATURE	-40°C	-20°C	0°C	23°C	30°C	40°C	50°C	60°C	70°C	85°C	125°C
DERATING %	143%	129%	116%	100%	93%	87%	80%	72%	65%	55%	26%

Typical Time-To-Trip at 23°C

- A = FHT050-30F K = FHT700-16F
- B = FHT070-30F L = FHT750-16F
- C = FHT100-30F M = FHT800-16F
- D = FHT200-16F N = FHT900-16F
- E = FHT300-16F O = FHT1000-16F
- F = FHT400-16F P = FHT1100-16F
- G = FHT450-16F Q = FHT1300-16F
- H = FHT550-16F R = FHT1400-16F
- I = FHT600-16F S = FHT1500-16F
- J = FHT650-16F

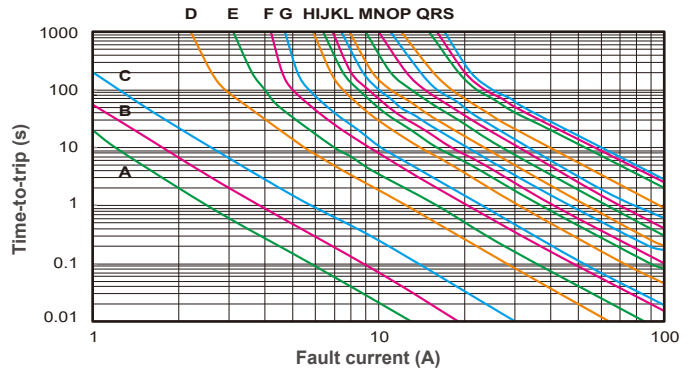

FHT Product Dimensions (mm)

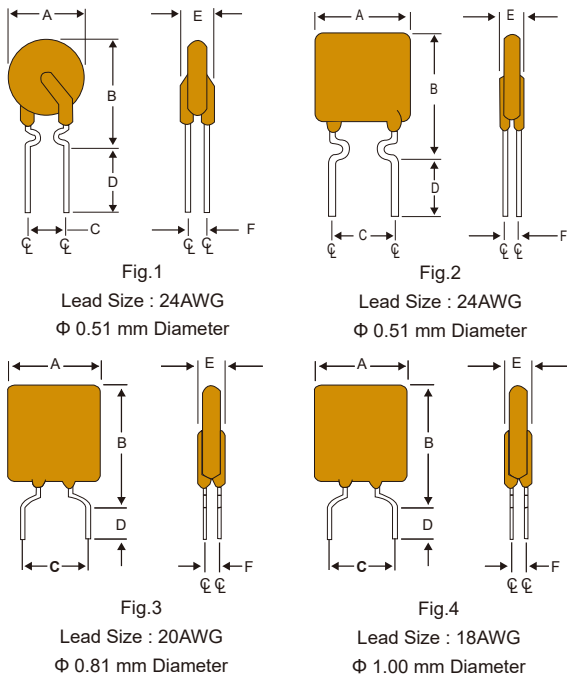

Part Number	Fig.	A	B	C	D	E	F
		Max.	Max.	Typ.	Min.	Max.	Typ.
FHT050-30F	1	7.4	12.7	5.1	7.6	3.0	1.2
FHT070-30F	2	6.9	10.8	5.1	7.6	3.0	1.2
FHT100-30F	1	9.7	13.6	5.1	7.6	3.0	1.2
FHT200-16F	1	9.4	14.4	5.1	7.6	3.0	1.2
FHT300-16F	3	8.8	13.8	5.1	7.6	3.0	1.2
FHT400-16F	3	10.0	15.0	5.1	7.6	3.0	1.2
FHT450-16F	3	10.4	15.6	5.1	7.6	3.0	1.2
FHT550-16F	3	11.2	18.9	5.1	7.6	3.0	1.2
FHT600-16F	3	11.2	21.0	5.1	7.6	3.0	1.2
FHT650-16F	3	12.7	22.2	5.1	7.6	3.0	1.2
FHT700-16F	3	14.0	21.9	5.1	7.6	3.0	1.2
FHT750-16F	3	14.0	23.5	5.1	7.6	3.0	1.2
FHT800-16F	3	16.5	22.5	5.1	7.6	3.0	1.2
FHT900-16F	3	16.5	25.7	5.1	7.6	3.0	1.2
FHT1000-16F	3	17.5	26.5	10.2	7.6	3.0	1.2
FHT1100-16F	3	21.0	26.1	10.2	7.6	3.0	1.2
FHT1300-16F	4	23.5	28.7	10.2	7.6	3.6	1.4
FHT1400-16F	4	23.5	28.7	10.2	7.6	3.6	1.4
FHT1500-16F	4	23.5	28.7	10.2	7.6	3.6	1.4

Part Numbering System

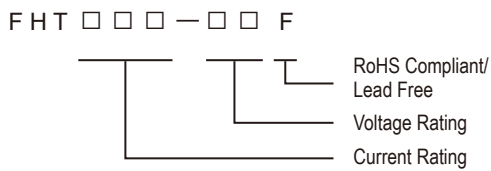

Part Marking System

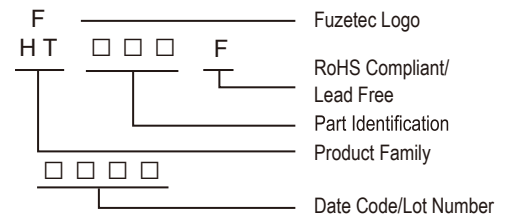

Package Information

Part Number	Standard Package
FHT050-30F~FHT300-16F	500 Pcs/Bag, 2.5K Reel/Tape
FHT400-16F	300 Pcs/Bag, 2.5K Reel/Tape
FHT450-16F~FHT550-16F	300 Pcs/Bag, 1.5K Reel/Tape
FHT600-16F	200 Pcs/Bag, 1.5K Reel/Tape
FHT650-16F~FHT700-16F	200 Pcs/Bag
FHT750-16F~FHT1500-16F	100 Pcs/Bag

Physical specifications

Lead material	FHT050-30F~FHT100-30F and FHT200-16F Tin plated copper clad steel, 24 AWG.
	FHT300-16F~FHT1100-16F Tin plated copper, 20 AWG.
	FHT1300-16F~FHT1500-16F Tin plated copper, 18 AWG.
Soldering characteristics	MIL-STD-202, Method 208E.
Insulating coating	Flame retardant epoxy, meets UL-94V-0 requirement.

Warning :



- Each product should be carefully evaluated and tested for their suitability of application.
- Operation beyond the specified maximum ratings or improper use may result in damage and possible electrical arcing and/or flame.
- PPTC device are intended for occasional overcurrent protection. Application for repeated overcurrent condition and/or prolonged trip are not anticipated.
- Avoid contact of PPTC device with chemical solvent, including some inert material such as silicone based oil, lubricant and etc. Prolonged contact will damage the device performance.
- Additional protection mechanism are strongly recommended to be used in conjunction with the PPTC device for protection against abnormal or failure conditions.
- Avoid use of PPTC device in a constrained space such as potting material, housing and containers where have limited space to accommodate device thermal expansion and/or contraction.

NOTE : All Specifications subject to change without notice.

FHE Series



Application

Wide variety of electronic equipment

Product Features

Very Low resistance, Very High hold current, Solid state, Radial leaded product ideal for up to 32V and Operating temperatures up to 125°C.



Operation Current

0.50A~10.00A

Maximum Voltage

32V



Temperature Range

-40°C to 125°C

Agency Recognition

AGENCY	AGENCY FILE NUMBER
	UL(E211981)
	C-UL(E211981)
	TÜV (R50004084)



Electrical Characteristics (23°C)

Part Number	Hold Current I_H , A	Trip Current I_T , A	Max. Time to trip at $5xI_H$, s	Max. Current I_{MAX} , A	Rated Voltage V_{MAX} , V _{DC}	Typ. Power P_d , W	Resistance	
							R_{MIN} Ohms	$R1_{MAX}$ Ohms
FHE050-32F	0.5	1.0	3.0	100	32	0.9	0.3500	1.1000
FHE070-32F	0.7	1.4	3.2	100	32	1.4	0.2300	0.8000
FHE100-32F	1.0	1.9	6.2	100	32	1.4	0.1500	0.4300
FHE200-32F	2.0	4.0	5.5	100	32	2.2	0.0650	0.2500
FHE300-32F	3.0	6.0	5.0	100	32	3.2	0.0350	0.1100
FHE500-32F	5.0	10.0	9.0	100	32	5.3	0.0150	0.0400
FHE750-32F	7.5	15.0	13.0	100	32	6.5	0.0074	0.0230
FHE1000-32F	10.0	20.0	15.0	100	32	7.0	0.0060	0.0160

Thermal Derating for PPTC Device at Various Ambient Temperatures

TEMPERATURE	-40°C	-20°C	0°C	23°C	30°C	40°C	50°C	60°C	70°C	85°C	125°C
DERATING %	143%	130%	115%	100%	92%	88%	80%	72%	65%	55%	28%

Typical Time-To-Trip at 23°C

- A = FHE050-32F
- B = FHE070-32F
- C = FHE100-32F
- D = FHE200-32F
- E = FHE300-32F
- F = FHE500-32F
- G = FHE750-32F
- H = FHE1000-32F

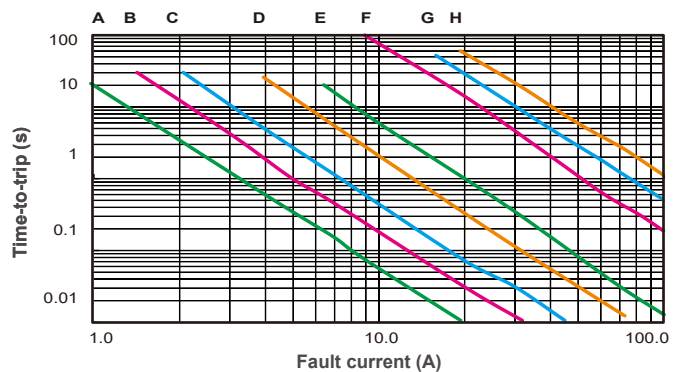

FHE Product Dimensions (mm)

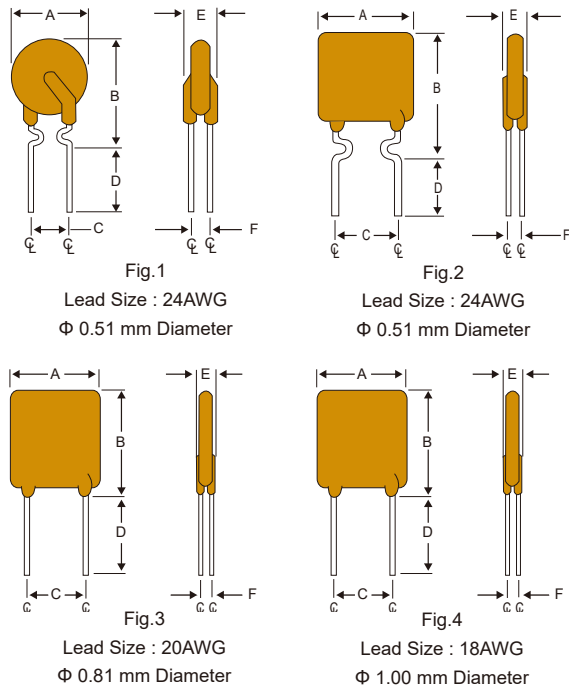

Part Number	Fig.	A	B	C	D	E
		Max.	Max.	Typ.	Min.	Max.
FHE050-32F	1	7.4	12.7	5.1	7.6	3.3
FHE070-32F	2	6.9	10.8	5.1	7.6	3.0
FHE100-32F	1	9.7	13.6	5.1	7.6	3.0
FHE200-32F	3	9.5	13.5	5.1	7.6	3.0
FHE300-32F	3	10.2	15.5	5.1	7.6	3.8
FHE500-32F	3	14.0	24.1	5.1	7.6	3.8
FHE750-32F	3	21.1	24.9	10.2	7.6	3.8
FHE1000-32F	4	23.5	27.9	10.2	7.6	4.0

Part Numbering System

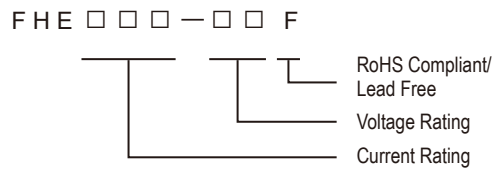

Part Marking System

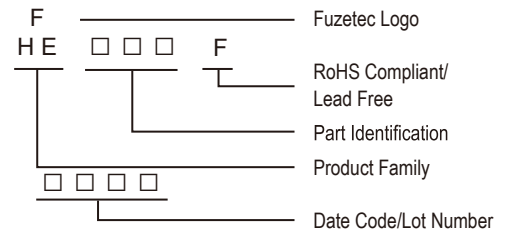

Package Information

Part Number	Standard Package
FHE050-32F~FHE070-32F	: 500Pcs/Bag, 2.5K Reel/Tape
FHE100-32F~FHE200-32F	: 300Pcs/Bag, 1.5K Reel/Tape
FHE300-32F	: 200Pcs/Bag, 1.5K Reel/Tape
FHE500-32F	: 200Pcs/Bag
FHE750-32F~FHE1000-32F	: 100Pcs/Bag

Physical specifications

Lead material	FHE050-32F~FHE100-32F Tin plated copper clad steel, 24 AWG.
	FHE200-32F~FHE750-32F Tin plated copper, 20 AWG.
	FHE1000-32F Tin plated copper, 18 AWG.
Soldering characteristics	MIL-STD-202, Method 208E.
Insulating coating	Flame retardant epoxy, meets UL-94V-0 requirement.
*NOTE : Font on Marking may look slightly different due to fine turning of each Marking printer.	

Warning :



- Each product should be carefully evaluated and tested for their suitability of application.
- Operation beyond the specified maximum ratings or improper use may result in damage and possible electrical arcing and/or flame.
- PPTC device are intended for occasional overcurrent protection. Application for repeated overcurrent condition and/or prolonged trip are not anticipated.
- Avoid contact of PPTC device with chemical solvent, including some inert material such as silicone based oil, lubricant and etc. Prolonged contact will damage the device performance.
- Additional protection mechanism are strongly recommended to be used in conjunction with the PPTC device for protection against abnormal or failure conditions.
- Avoid use of PPTC device in a constrained space such as potting material, housing and containers where have limited space to accommodate device thermal expansion and/or contraction.

FSMDH Series



Application

All high-density boards

Product Features

Small surface mountable, Solid state, Faster time to trip than standard SMD devices, Lower resistance than standard SMD devices



Operation Current

0.05A~1.10A

Maximum Voltage

6V~30V_{DC}



Temperature Range

-40°C to 125°C

Agency Recognition

AGENCY	AGENCY FILE NUMBER
	UL(E211981)
	C-UL(E211981)
	TÜV (R50090556)



SVHC Compliant

Electrical Characteristics (23°C)

Part Number	Hold Current	Trip Current	Rated Voltage	Max. Current	Typ. Power	Max. Time to trip		Resistance	
						Current	Time	R _{MIN}	R _{1MAX}
								A	Sec
FSMDH005-0805-R	0.05	0.18	16	40	0.6	0.50	0.08	3.50	38.00
FSMDH005-30-0805-R	0.05	0.18	30	40	0.6	0.50	0.08	3.50	38.00
FSMDH010-0805-R	0.10	0.60	16	40	1.0	2.50	1.50	1.00	12.00
FSMDH020-0805-R	0.20	0.70	16	40	0.9	8.00	0.10	0.75	3.40
FSMDH010-1206-R	0.10	0.35	30	10	0.8	1.00	0.10	1.10	10.00
FSMDH016-1206-R	0.16	0.80	30	80	0.9	8.00	0.10	0.70	6.00
FSMDH020-1206-R	0.20	0.50	30	10	0.9	8.00	0.10	0.60	4.50
FSMDH030-24-1206-R	0.30	0.82	24	10	1.0	8.00	0.10	0.50	1.95
FSMDH035-1206-R	0.35	0.95	16	80	1.0	3.50	0.20	0.20	1.60
FSMDH035-30-1206R	0.35	1.75	30	80	1.2	8.00	0.10	0.40	2.20
FSMDH050-24-1206-R	0.50	2.50	24	20	1.7	8.00	0.10	0.20	1.60
FSMDH075-1206-R	0.75	2.00	6	10	1.1	8.00	0.10	0.10	0.36
FSMDH010-1210-R	0.10	0.35	30	10	0.9	1.00	0.50	1.20	11.00
FSMDH020-1210-R	0.20	0.50	30	10	0.9	8.00	0.10	0.80	5.00
FSMDH035-1210-R	0.35	1.75	30	20	1.0	8.00	0.10	0.40	2.20
FSMDH050-1210-R	0.50	1.50	6	10	1.1	8.00	0.05	0.19	0.90
FSMDH050-30-1210R	0.50	2.50	30	20	1.0	8.00	0.10	0.30	1.60
FSMDH050-R	0.50	1.60	30	20	1.2	8.00	0.10	0.20	1.35
FSMDH110-R	1.10	2.20	6	40	1.2	8.00	1.00	0.05	0.43
FSMDH110-16-R	1.10	5.50	16	40	1.2	8.00	1.00	0.05	0.43
FSMDH110-2920-R	1.10	2.20	16	50	2.0	8.00	2.00	0.09	0.41

*Note: FSMDH005-30-1210R UL/C-UL Pending , FSMDH005-30-0805-R TÜV Pending.

Thermal Derating for PPTC Device at Various Ambient Temperatures

TEMPERATURE	-40°C	-20°C	0°C	20°C	40°C	60°C	85°C	100°C	125°C
DERATING %	135%	122%	110%	100%	90%	75%	65%	53%	40%

Typical Time-To-Trip at 23°C

FSMDH0805 Series

- A = FSMDH005-0805-R
FSMDH005-30-0805-R
- B = FSMDH010-0805-R
- C = FSMDH020-0805-R

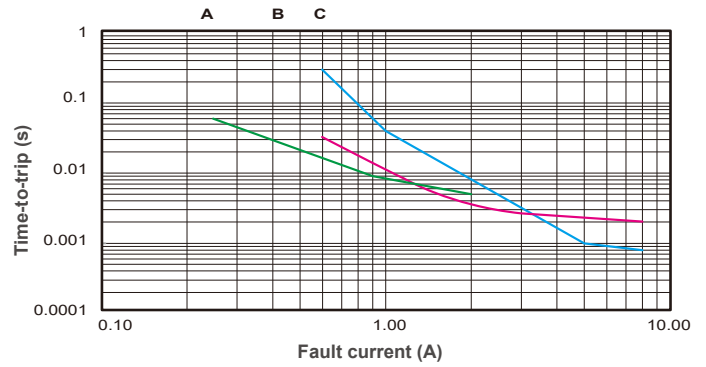

FSMDH1206 Series

- A = FSMDH010-1206-R
- B = FSMDH016-1206-R
- C = FSMDH020-1206-R
- D = FSMDH035-1206-R
- E = FSMDH035-30-1206R
- F = FSMDH030-24-1206-R
FSMDH050-24-1206-R
- G = FSMDH075-1206R

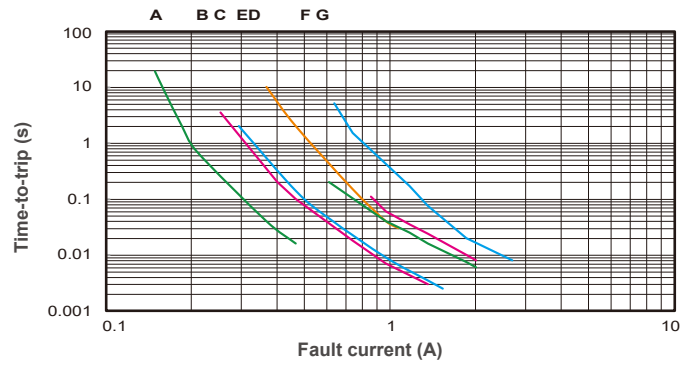

FSMDH1210 Series

- A = FSMDH010-1210-R
- B = FSMDH020-1210-R
- C = FSMDH035-1210-R
- D = FSMDH050-1210-R
- E = FSMDH050-30-1210R

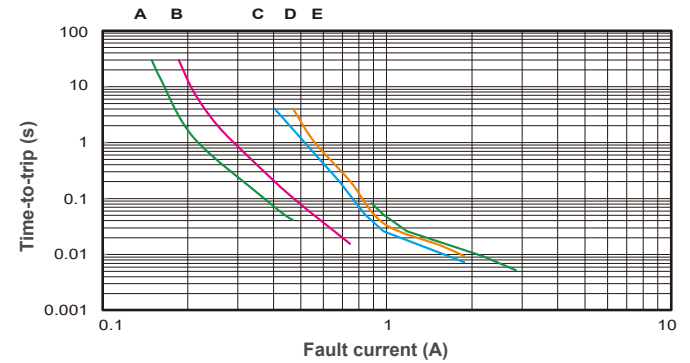

FSMDH1812 Series

- A = FSMDH050-R
- B = FSMDH110-R, FSMDH110-16-R

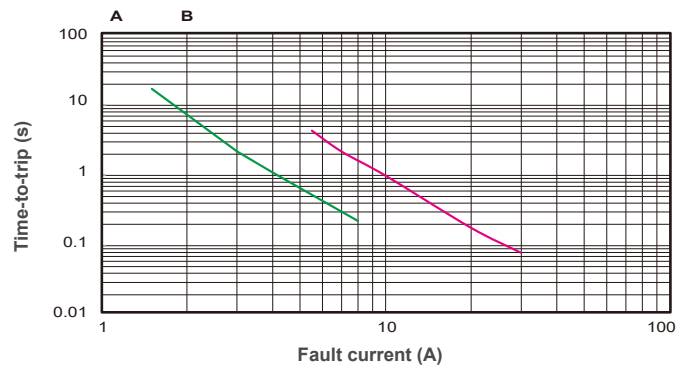

FSMDH2920 Series

- A = FSMDH110-2920-R

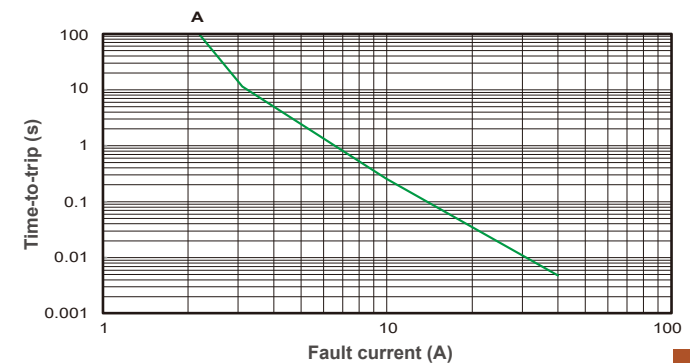

FSMDH Product Dimensions (mm)

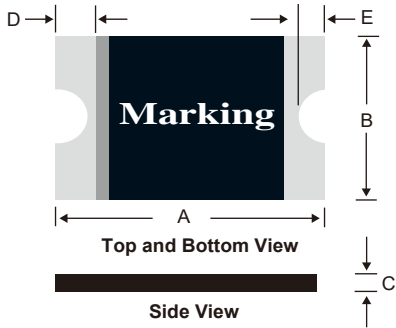

*For Reflow Soldering Profile information, please refer to P.80 "IX APPENDIX - SMD PRODUCT SOLDER REFLOW RECOMMENDATIONS"

Part Number	A		B		C		D		E	
	Min.	Max.	Min.	Max.	Min.	Max.	Min.	Max.	Min.	Max.
FSMDH005-0805-R	2.00	2.30	1.20	1.50	0.40	0.80	0.20	0.60	0.10	0.45
FSMDH005-30-0805-R	2.00	2.30	1.20	1.50	0.30	1.00	0.20	0.60	0.10	0.45
FSMDH010-0805-R	2.00	2.30	1.20	1.50	0.40	0.80	0.20	0.60	0.10	0.45
FSMDH020-0805-R	2.00	2.30	1.20	1.50	0.40	0.80	0.20	0.60	0.10	0.45
FSMDH010-1206-R	3.00	3.50	1.50	1.80	0.30	1.20	0.10	0.75	0.10	0.45
FSMDH016-1206-R	3.00	3.50	1.50	1.80	0.30	1.10	0.10	0.75	0.10	0.45
FSMDH020-1206-R	3.00	3.50	1.50	1.80	0.30	1.10	0.10	0.75	0.10	0.45
FSMDH030-24-1206-R	3.00	3.50	1.50	1.80	0.30	1.10	0.10	0.75	0.10	0.45
FSMDH035-1206-R	3.00	3.50	1.50	1.80	0.30	1.10	0.10	0.75	0.10	0.45
FSMDH035-30-1206R	3.00	3.50	1.50	1.80	0.40	1.70	0.10	0.75	0.10	0.45
FSMDH050-24-1206-R	3.00	3.50	1.50	1.80	0.30	1.10	0.10	0.75	0.10	0.45
FSMDH075-1206-R	3.00	3.50	1.50	1.80	0.25	1.50	0.10	0.75	0.10	0.45
FSMDH010-1210-R	3.00	3.43	2.35	2.80	0.30	1.20	0.25	0.75	0.10	0.45
FSMDH020-1210-R	3.00	3.43	2.35	2.80	0.30	1.20	0.25	0.75	0.10	0.45
FSMDH035-1210-R	3.00	3.43	2.35	2.80	0.30	1.20	0.25	0.75	0.10	0.45
FSMDH050-1210-R	3.00	3.43	2.35	2.80	0.30	1.20	0.25	0.75	0.10	0.45
FSMDH050-30-1210R	3.00	3.43	2.35	2.80	0.30	1.20	0.25	0.75	0.10	0.45
FSMDH050-R	4.37	4.73	3.07	3.41	0.25	0.75	0.30	0.95	0.25	0.65
FSMDH110-R	4.37	4.73	3.07	3.41	0.25	0.75	0.30	0.95	0.25	0.65
FSMDH110-16-R	4.37	4.73	3.07	3.41	0.25	0.75	0.30	0.95	0.25	0.65
FSMDH110-2920-R	6.73	7.98	4.80	5.44	0.30	1.70	0.50	1.20	0.50	0.90

Part Numbering System

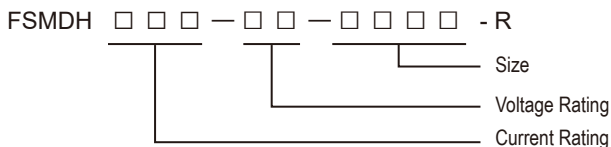
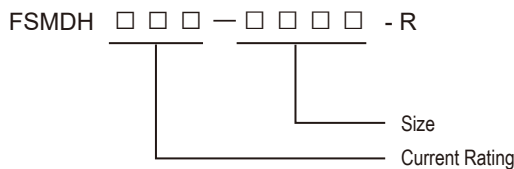

Part Marking System

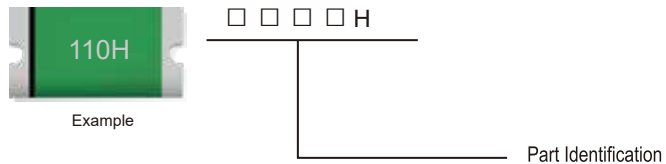

DH =	FSMDH005-0805-R	10H =	FSMDH010-1210-R
FH =	FSMDH005-30-0805-R	20H =	FSMDH020-1210-R
1H =	FSMDH010-0805-R	35H =	FSMDH035-1210-R
2H =	FSMDH020-0805-R	50H =	FSMDH050-1210-R
AH =	FSMDH010-1206-R	50H =	FSMDH050-30-1206R
KH =	FSMDH016-1206-R		
BH =	FSMDH020-1206-R	050H =	FSMDH050-R
JH =	FSMDH030-24-1206-R	110H =	FSMDH110-R
MH =	FSMDH035-1206-R	110H =	FSMDH110-16-R
CH =	FSMDH035-30-1206R	16	
NH =	FSMDH050-24-1206-R	110LH =	FSMDH110-2920-R
EH =	FSMDH075-1206R		

Package Information

Part Number	Standard Package
FSMDH005-0805-R~FSMDH020-0805-R	: 4.0K Reel/Tape
FSMDH010-1206-R~FSMDH020-1206-R	: 3.0K Reel/Tape
FSMDH035-1206-R	: 3.0K Reel/Tape
FSMDH035-30-1206R	: 2.0K Reel/Tape
FSMDH050-24-1206-R	: 3.0K Reel/Tape
FSMDH010-1210-R~ FSMDH050-1210-R	: 3.0K Reel/Tape
FSMDH050-R~ FSMDH110-R	: 2.0K Reel/Tape
FSMDH110-2920-R	: 2.0K Reel/Tape

Physical specifications

Termination pad materials	Pure Tin
Soldering characteristics	Meets EIA specification RS 186-9E, ANSI/J-std-002 Category 3

Warning :



- Each product should be carefully evaluated and tested for their suitability of application.
- Operation beyond the specified maximum ratings or improper use may result in damage and possible electrical arcing and/or flame.
- PPTC device are intended for occasional overcurrent protection. Application for repeated overcurrent condition and/or prolonged trip are not anticipated.
- Avoid contact of PPTC device with chemical solvent, including some inert material such as silicone based oil, lubricant and etc. Prolonged contact will damage the device performance.
- Additional protection mechanism are strongly recommended to be used in conjunction with the PPTC device for protection against abnormal or failure conditions.
- Avoid use of PPTC device in a constrained space such as potting material, housing and containers where have limited space to accommodate device thermal expansion and/or contraction.



FUZETEC

Fuzetec Disc, Ring & Custom Shaped PPTC Devices Offers Customized Overcurrent Protections to Tailor Fit Engineer Design Specification and Meet Customer Requirements

Customized
Products



Automotive Customized Products

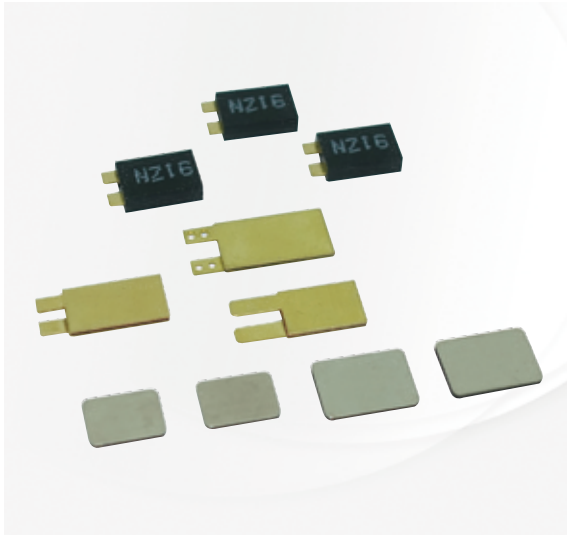

Terminal PPTC FCTS XXXXX Special terminal PPTC devices are designed for automotive motor applications, protect potential motor stalling overcurrent condition caused by abnormal operation; custom shape and configuration offer better design flexibility.



Application
Automotive motor applications.

Product Features
Custom shaped PPTC devices to fit into motor structure.
Trip-time & resistance adjustable.
Outstanding shock & vibration resistant
Automotive grade high temperature up to 125°C



Operation Current
Trip Current up to 15A/Maximum current capability up to 50A

Operation Voltage
12V~30V_{DC}; High voltage capability up to 60V_{DC}



Temperature Range
-40°C ~ 85°C/125°C

Terminal PPTC w/ Housing FCTS XXXXX-S Terminal PPTC devices with exterior housing, provide more reliable performance under high temperature environment.

Chip PPTC Small-sized custom shaped PPTC for small electric motor application.

Battery/Energy Customized

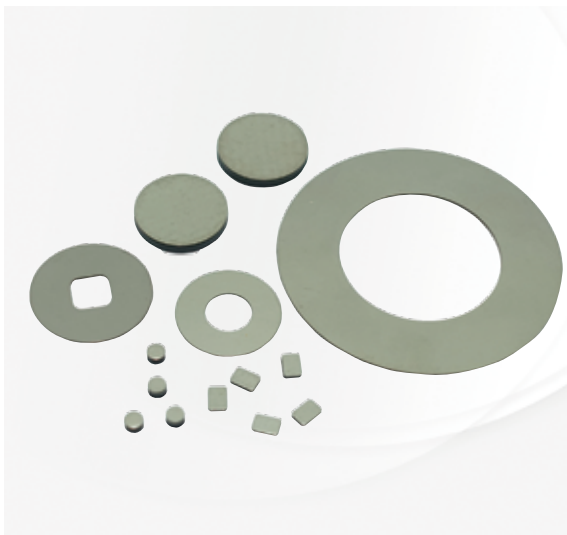

Battery Disc/Ring PPTC FDC XXXXX Custom designed disc and ring shaped PPTC devices for consumer, vehicle, ship and military battery applications, high current and voltage rating products available.



Application
Battery and Energy Applications

Product Features
High Current / High Voltage capability for the emerging market demand for high power battery and energy solution for connected equipments.



Operation Current
Battery Series
2.00A~8A; high current capability up to 33A for special battery applications

Energy Series
0.16A~2.00A for high voltage AC/DC application

Operation Voltage
Battery Series
3V~16V_{DC}; High voltage capability up to 60V_{DC}

Energy Series
Rated Voltage 240V_{AC/DC}, Max.Int. Voltage 265V_{AC/DC}



Temperature Range
-40°C ~ 85°C/125°C

Energy Chip PPTC Series FCT XXXXX Base on Fuzetec high voltage PPTC formulation, special design for energy applications with surge immunity requirements, for more information about Energy Chip PPTC series, please contact with Fuzetec.

X - APPENDIX- CROSS REFERENCE

Fuzetec		Tyco (Raychem)		Bourns		Littelfuse		Polytronics	
FRX	005-60F	RXEF	005	MF-R	005	--	--	RLD60P	005XF
FRX	010-60F	RXEF	010	MF-R	010	60R	010X	RLD60P	010XF
FRX	017-60F	RXEF	017	MF-R	017	60R	017X	RLD60P	017XF
FRX	020-60F	--	--	MF-R	020	60R	020X	RLD60P	020XF
FRX	025-60F	--	--	MF-R	025	60R	025X	RLD60P	025XF
FRX	030-60F	--	--	MF-R	030	60R	030X	RLD60P	030XF
FRX	040-60F	--	--	MF-R	040	60R	040X	RLD60P	040XF
FRX	050-60F	--	--	MF-R	050	60R	050X	RLD60P	050XF
FRX	065-60F	--	--	MF-R	065	60R	065X	RLD60P	065XF
FRX	075-60F	--	--	MF-R	075	60R	075X	RLD60P	075XF
FRX	090-60F	--	--	MF-R	090	60R	090X	RLD60P	090XF
FRX	110-60F	--	--	MF-RX	110	60R	110X	RLD60P	110XF
FRX	135-60F	--	--	MF-RX	135	60R	135X	RLD60P	135XF
FRX	160-60F	--	--	MF-RX	160	60R	160X	RLD60P	160XF
FRX	185-60F	--	--	MF-RX	185	60R	185X	RLD60P	185XF
FRX	250-60F	--	--	MF-RX	250	60R	250X	RLD60P	250XF
FRX	300-60F	--	--	MF-RX	300	60R	300X	RLD60P	300XF
FRX	375-60F	--	--	MF-RX	375	60R	375X	RLD60P	375XF
FRX	010-90F	--	--	--	--	--	--	--	--
FRX	015-90F	--	--	--	--	--	--	--	--
FRX	017-90F	--	--	--	--	--	--	--	--
FRX	020-90F	RXEF	020	MF-RX	020/72	72R	020X	RLD72P	020XF
FRX	025-90F	RXEF	025	MF-RX	025/72	72R	025X	RLD72P	025XF
FRX	030-90F	RXEF	030	MF-RX	030/72	72R	030X	RLD72P	030XF
FRX	035-90F	--	--	--	--	--	--	--	--
FRX	040-90F	RXEF	040	MF-RX	040/72	72R	040X	RLD72P	040XF
FRX	050-90F	RXEF	050	MF-RX	050/72	72R	050X	RLD72P	050XF
FRX	055-90F	--	--	--	--	--	--	--	--
FRX	065-90F	RXEF	065	MF-RX	065/72	72R	065X	RLD72P	065XF
FRX	075-90F	RXEF	075	MF-RX	075/72	72R	075X	RLD72P	075XF
FRX	090-90F	RXEF	090	MF-RX	090/72	72R	090X	RLD72P	090XF
FRX	110-90F	RXEF	110	MF-RX	110/72	72R	110X	RLD72P	110XF
FRX	135-90F	RXEF	135	MF-RX	135/72	72R	135X	RLD72P	135XF
FRX	160-90F	RXEF	160	MF-RX	160/72	72R	160X	RLD72P	160XF
FRX	185-90F	RXEF	185	MF-RX	185/72	72R	185X	RLD72P	185XF
FRX	250-90F	RXEF	250	MF-RX	250/72	72R	250X	RLD72P	250XF
FRX	300-90F	RXEF	300	MF-RX	300/72	72R	300X	RLD72P	300XF
FRX	375-90F	RXEF	375	MF-RX	375/72	72R	375X	RLD72P	375XF
FUSB	075F	RUSBF	075	--	--	06R	075B	RLD06P	075BF
FUSB	090F	RUSBF	090	--	--	16R	090B	RLD16P	090BF
FUSB	110F	RUSBF	110	--	--	16R	110B	RLD16P	110BF
FUSB	120F	RUSBF	120	--	--	06R	120B	RLD06P	120BF
FUSB	135F	RUSBF	135	--	--	16R	135B	RLD16P	135BF
FUSB	155F	RUSBF	155	--	--	06R	155B	RLD06P	155BF
FUSB	160F	RUSBF	160	--	--	16R	160B	RLD16P	160BF
FUSB	185F	RUSBF	185	--	--	16R	185B	RLD16P	185BF
FUSB	250F	RUSBF	250	--	--	16R	250B	RLD16P	250BF
FRU	090-30F	RUEF	090	MF-R	090-0-9	30R	090U	RLD30P	090UF
FRU	110-30F	RUEF	110	MF-R	110	30R	110U	RLD30P	110UF
FRU	135-30F	RUEF	135	MF-R	135	30R	135U	RLD30P	135UF
FRU	160-30F	RUEF	160	MF-R	160	30R	160U	RLD30P	160UF
FRU	185-30F	RUEF	185	MF-R	185	30R	185U	RLD30P	185UF
FRU	250-30F	RUEF	250	MF-R	250	30R	250U	RLD30P	250UF
FRU	300-30F	RUEF	300	MF-R	300	30R	300U	RLD30P	300UF
FRU	400-30F	RUEF	400	MF-R	400	30R	400U	RLD30P	400UF
FRU	500-30F	RUEF	500	MF-R	500	30R	500U	RLD30P	500UF
FRU	600-30F	RUEF	600	MF-R	600	30R	600U	RLD30P	600UF
FRU	700-30F	RUEF	700	MF-R	700	30R	700U	RLD30P	700UF
FRU	800-30F	RUEF	800	MF-R	800	30R	800U	RLD30P	800UF
FRU	900-30F	RUEF	900	MF-R	900	30R	900U	RLD30P	900UF

Fuzetec		Tyco (Raychem)		Bourns		Littelfuse		Polytronics	
FRT	050-33F	--	--	--	--	--	--	--	--
FRT	075-33F	--	--	--	--	--	--	--	--
FRT	090-33F	--	--	--	--	--	--	--	--
FRT	120-33F	RTEF	120	--	--	--	--	--	--
FRT	135-33F	RTEF	135	--	--	--	--	--	--
FRT	160-33F	--	--	--	--	--	--	--	--
FRT	190-33F	RTEF	190	--	--	--	--	--	--
FRT	220-33F	--	--	--	--	--	--	--	--
FRT	250-33F	--	--	--	--	--	--	--	--
FRG	250-16F	RGEF	250	--	--	16R	250G	RLD16P	250GF
FRG	300-16F	RGEF	300	MF-RG	300	16R	300G	RLD16P	300GF
FRG	400-16F	RGEF	400	MF-RG	400	16R	400G	RLD16P	400GF
FRG	500-16F	RGEF	500	MF-RG	500	16R	500G	RLD16P	500GF
FRG	600-16F	RGEF	600	MF-RG	600	16R	600G	RLD16P	600GF
FRG	700-16F	RGEF	700	MF-RG	700	16R	700G	RLD16P	700GF
FRG	800-16F	RGEF	800	MF-RG	800	16R	800G	RLD16P	800GF
FRG	900-16F	RGEF	900	MF-RG	900	16R	900G	RLD16P	900GF
FRG	1000-16F	RGEF	1000	MF-RG	1000	16R	1000G	RLD16P	1000GF
FRG	1100-16F	RGEF	1100	MF-RG	1100	16R	1100G	RLD16P	1100GF
FRG	1200-16F	RGEF	1200	--	--	16R	1200G	RLD16P	1200GF
FRG	1400-16F	RGEF	1400	--	--	16R	1400G	RLD16P	1400GF
FHT	050-30F	RHEF	050	MF-RHT	050	--	--	--	--
FHT	070-30F	RHEF	070	MF-RHT	070	--	--	--	--
FHT	100-30F	RHEF	100	MF-RHT	100	--	--	--	--
FHT	200-16F	RHEF	200	MF-RHT	200	--	--	--	--
FHT	300-16F	RHEF	300	MF-RHT	300	--	--	--	--
FHT	400-16F	RHEF	400	MF-RHT	400	--	--	--	--
FHT	450-16F	RHEF	450	MF-RHT	450	--	--	--	--
FHT	550-16F	RHEF	550	MF-RHT	550	--	--	--	--
FHT	600-16F	RHEF	600	MF-RHT	600	--	--	--	--
FHT	650-16F	RHEF	650	MF-RHT	650	--	--	--	--
FHT	700-16F	RHEF	700	MF-RHT	700	--	--	--	--
FHT	750-16F	RHEF	750	MF-RHT	750	--	--	--	--
FHT	800-16F	RHEF	800	MF-RHT	800	--	--	--	--
FHT	900-16F	RHEF	900	MF-RHT	900	--	--	--	--
FHT	1000-16F	RHEF	1000	MF-RHT	1000	--	--	--	--
FHT	1100-16F	RHEF	1100	MF-RHT	1100	--	--	--	--
FHT	1300-16F	RHEF	1300	MF-RHT	1300	--	--	--	--
FHT	1400-16F	RHEF	1400	--	--	--	--	--	--
FHT	1500-16F	RHEF	1500	--	--	--	--	--	--
FHE	050-32F	AHEF	050	--	--	--	--	--	--
FHE	070-32F	AHEF	070	--	--	--	--	--	--
FHE	100-32F	AHEF	100	--	--	--	--	--	--
FHE	200-32F	--	--	--	--	--	--	--	--
FHE	300-32F	AHEF	300	--	--	--	--	--	--
FHE	500-32F	AHEF	500	--	--	--	--	--	--
FHE	750-32F	AHEF	750	--	--	--	--	--	--
FHE	1000-32F	AHEF	1000	--	--	--	--	--	--
FRH	080-250VF	TRF	250-080T	--	--	250R	080	HVR250P	080CF
FRH	110-250VF	--	--	--	--	--	--	--	--
FRH	120-250VF	TRF	250-120	MF-RX	012/250	250R	120	HVR250P	120CF
FRH	145-250VF	TRF	250-145	MF-RX	014/250	250R	145	HVR250P	145CF
FRH	180-250XF	TRF	250-180	MF-RX	018/250	250R	180	HVR250P	180CF
FRH	150-600MF	TRF	600-150	MF-R	015/600	600R	150	HVR600P	150CF
FRH	160-600MF	--	--	--	--	--	--	--	--
FRH	160-600VF	TRF	600-160	MF-R	016/600	600R	160	HVR600P	160CF
FRH	200-600VF	--	--	--	--	--	--	--	--
FRH	250-600VF	TRF	600-250	--	--	--	--	--	--
FRH	400-600F	TRF	600-400	--	--	--	--	--	--

X - APPENDIX- CROSS REFERENCE

Fuzetec		Tyco (Raychem)		Bourns		Littelfuse		Polytronics	
FRV	005-240F	LVR	005NS	MF-RM	005/240	--	--	--	--
FRV	008-240F	LVR	008NS	MF-RM	008/240	--	--	--	--
FRV	012-240F	LVR	012S	MF-RM	012/240	--	--	--	--
FRV	016-240F	LVR	016S	MF-RM	016/240	--	--	--	--
FRV	025-240F	LVR	025S	MF-RM	025/240	--	--	--	--
FRV	033-240F	LVR	033S	MF-RM	033/240	--	--	--	--
FRV	040-240F	LVR	040S	MF-RM	040/240	--	--	--	--
FRV	055-240F	LVR	055S	MF-RM	055/240	--	--	--	--
FRV	075-240F	LVR	075S	--	--	--	--	--	--
FRV	100-240F	LVR	100S	--	--	--	--	--	--
FRV	125-240F	LVR	125S	--	--	--	--	--	--
FRV	150-240F	--	--	--	--	--	--	--	--
FRV	200-240F	--	--	--	--	--	--	--	--
FRV	005-277F	--	--	--	--	--	--	--	--
FRV	008-277F	--	--	--	--	--	--	--	--
FRV	012-277F	--	--	--	--	--	--	--	--
FRV	016-277F	--	--	--	--	--	--	--	--
FRV	025-277F	--	--	--	--	--	--	--	--
FRV	033-277F	--	--	--	--	--	--	--	--
FRV	040-277F	--	--	--	--	--	--	--	--
FRV	055-277F	--	--	--	--	--	--	--	--
FRV	075-277F	--	--	--	--	--	--	--	--
FRV	100-277F	--	--	--	--	--	--	--	--
FRV	125-277F	--	--	--	--	--	--	--	--
FRV	150-277F	--	--	--	--	--	--	--	--
FRV	200-277F	--	--	--	--	--	--	--	--
FRVL	010-120F	--	--	--	--	--	--	--	--
FRVL	017-120F	--	--	--	--	--	--	--	--
FRVL	020-120F	--	--	--	--	--	--	--	--
FRVL	025-120F	--	--	--	--	--	--	--	--
FRVL	030-120F	--	--	--	--	--	--	--	--
FRVL	040-120F	--	--	--	--	--	--	--	--
FRVL	050-120F	--	--	--	--	--	--	--	--
FRVL	065-120F	--	--	--	--	--	--	--	--
FRVL	070-120F	--	--	--	--	--	--	--	--
FRVL	075-120F	LVRL	075S	--	--	--	--	--	--
FRVL	090-120F	--	--	--	--	--	--	--	--
FRVL	100-120F	LVRL	100S	--	--	--	--	--	--
FRVL	110-120F	--	--	--	--	--	--	--	--
FRVL	125-120F	LVRL	125S	--	--	--	--	--	--
FRVL	130-120F	--	--	--	--	--	--	--	--
FRVL	135-120F	LVRL	135S	--	--	--	--	--	--
FRVL	160-120F	--	--	--	--	--	--	--	--
FRVL	185-120F	--	--	--	--	--	--	--	--
FRVL	200-120F	LVRL	200S	--	--	--	--	--	--
FRVL	250-120F	--	--	--	--	--	--	--	--
FRVL	300-120F	--	--	--	--	--	--	--	--
FRVL	375-120F	--	--	--	--	--	--	--	--
FSR	120F	SRP	120F	MF-S	120	--	--	STD	120F
FSR	175F	SRP	175F	MF-S	175	--	--	STD	175F
FSR	200F	SRP	200F	MF-S	200	--	--	STD	200F
FSR	350F	SRP	350F	MF-S	350	--	--	STD	350F
FSR	420F	SRP	420F	MF-S	420	--	--	STD	420F
FLR	190F	LR4	190F	MF-LR	190	--	--	LRD	190F
FLR	260F	LR4	260F	MF-LR	260	--	--	LRD	260F
FLR	380F	LR4	380F	MF-LR	380	--	--	LRD	380F
FLR	450F	LR4	450F	MF-LR	450	--	--	LRD	450F
FLR	550F	LR4	550F	MF-LR	550	--	--	LRD	550F
FLR	600F	LR4	600F	MF-LR	600	--	--	LRD	600F
FLR	730F	LR4	730F	MF-LR	730	--	--	LRD	730F
FLR	900F	LR4	900F	MF-LR	900	--	--	LRD	900F

Fuzetec		Tyco (Raychem)		Bourns		Littelfuse		Polytronics	
FSMD*	030-2920-R	SMD	030F	MF-SM	030	2920L	030	SMD2920P	030TF
FSMD*	050-2920-R	SMD	050F	MF-SM	050	2920L	050	SMD2920P	050TF
FSMD*	075-2920-R	SMD	075F	MF-SM	075	2920L	075	SMD2920P	075TF
FSMD*	075-60-2920-R	SMD	075F/60	MF-SM	075/60	2920L	075/60	SMD2920P	075TF/60
FSMD*	100-2920-R	SMD	100F	MF-SM	100/33	2920L	100	SMD2920P	100TF
FSMD	110-60-2920R	--	--	--	--	2920L	110/60	SMD2920P	110TF
FSMD*	125-2920-R	SMDC	125F/33	MF-SM	125	2920L	125	SMD2920P	125TF
FSMD**	150-2920-R	SMD	150F/33	MF-SM	150/33	2920L	150	SMD2920P	150TF
FSMD**	185-2920-R	SMD	185F/33	MF-SM	185/33	2920L	185	SMD2920P	185TF
FSMD**	200-2920-R	SMD	200F	MF-SM	200	2920L	200	--	--
FSMD**	200-24-2920-R	SMD	200F/24	--	--	2920L	200/24	SMD2920P	200TF/24
FSMD**	250-2920-R	SMD	250F/15	MF-SM	250	2920L	250	SMD2920P	250TF
FSMD**	260-2920-R	SMD	260F	MF-SM	260	2920L	260	SMD2920P	260TF
FSMD*	260-24-2920R	--	--	--	--	2920L	260/24	SMD2920P	260TF/24
FSMD**	300-2920-R	SMD	300F	MF-SM	300	2920L	300	--	--
FSMD**	300-15-2920R	SMD	300F/15	--	--	2920L	300/15	SMD2920P	300TF/15
FSMD**	300-24-2920R	SMDC	300F/24	MF-LSMF	300/24X	--	--	--	--
FSMD	330-2920R	--	--	MF-LSMF	330/24X	2920L	330/24	SMD2920P	330TF
FSMD*	400-16-2920R	--	--	--	--	--	--	SMD2920P	400TF
FSMD*	500-16-2920R	--	--	--	--	2920L	500/16	SMD2920P	500TF/16
FSMD	005-240-2920-R	--	--	--	--	--	--	--	--
FSMD	008-240-2920-R	--	--	--	--	--	--	--	--
FSMD	012-240-2920-R	--	--	--	--	--	--	--	--
FSMD	013-240-2920-R	--	--	--	--	--	--	--	--
FSMD	016-240-2920-R	--	--	--	--	--	--	--	--
FSMD	030-2016-R	--	--	--	--	2016L	030	SMD2016P	030TF
FSMD	050-2016R	--	--	--	--	2016L	050	SMD2016P	050TF
FSMD	075-2016R	--	--	--	--	2016L	075/60	SMD2016P	075TF
FSMD	100-2016-R	--	--	--	--	2016L	100	SMD2016P	100TF
FSMD	100-33-2016-R	--	--	--	--	2016L	100/33	SMD2016P	100TF/33
FSMD	150-2016-R	--	--	--	--	2016L	150	SMD2016P	150TF
FSMD	200-2016-R	--	--	--	--	2016L	200	SMD2016P	200TF
FSMD	010-R	miniSMDC	010F	MF-MSMF	010	1812L	010	SMD1812P	010TF
FSMD	014-R	miniSMDC	014F	MF-MSMF	014	1812L	014	SMD1812P	014TF
FSMD	020-R	miniSMDC	020F	MF-MSMF	020	1812L	020	SMD1812P	020TF
FSMD	020-60-R	--	--	MF-MSMF	020/60	1812L	020/60	SMD1812P	020TF-J
FSMD	030-R	miniSMDC	030F	MF-MSMF	030	--	--	--	--
FSMD	035-R	--	--	--	--	--	--	--	--
FSMD	035-30-R	--	--	--	--	1812L	035/30	SMD1812P	035TF/30
FSMD	050-R	--	--	MF-MSMF	050	1812L	050	SMD1812P	050TF
FSMD	050-30-R	miniSMDC	050F	MF-MSMF	050/30X	1812L	050/30	SMD1812P	050TF/30
FSMD	075-R	miniSMDC	075F	MF-MSMF	075	1812L	075	SMD1812P	075TF
FSMD	075-24R	miniSMDC	075F/24	MF-MSMF	075/24	1812L	075/24	SMD1812P	075TF/24
FSMD	075-33R	miniSMDC	075F/33	MF-MSMF	075/33X	1812L	075/33	SMD1812P	075TF/33
FSMD	110-R	miniSMDC	110F	MF-MSMF	110	1812L	110	SMD1812P	110TF
FSMD	110-16-R	miniSMDC	110F/16	MF-MSMF	110/16	1812L	110/16	SMD1812P	110TF/16
FSMD	110-24R	miniSMDC	110F/24	MF-MSMF	110/24X	1812L	110/24	SMD1812P	110TF/24
FSMD	110-33R	--	--	--	--	1812L	110/33	SMD1812P	110TF/33
FSMD	125-R	miniSMDC	125F	MF-MSMF	125	1812L	125/6	--	--
FSMD	125-16R	miniSMDC	125F/16	--	--	1812L	125/16	SMD1812P	125TF/16
FSMD	150-R	miniSMDC	150F	MF-MSMF	150	1812L	150	SMD1812P	150TF/8
FSMD	150-12R	miniSMDC	150F/12	MF-MSMF	150/12	1812L	150/12	SMD1812P	150TF/12
FSMD	150-24R	miniSMDC	150F/24	MF-MSMF	150/24X	1812L	150/24	SMD1812P	150TF/24
FSMD	160-R	miniSMDC	160F	MF-MSMF	160	1812L	160	SMD1812P	160TF/8
FSMD	160-12R	--	--	--	--	1812L	160/12	--	--

X - APPENDIX- CROSS REFERENCE

Fuzetec	Tyco (Raychem)	Bourns	Littelfuse	Polytronics
FSMD 160-16R	--	--	--	--
FSMD 160-24R	--	--	--	--
FSMD 200R	miniSMDC 200F	MF-MSMF 200	1812L 200TH	SMD1812P 200TFT
FSMD 200-16R	miniSMDC 200F/16	--	1812L 200/16	SMD1812P 200TF/16
FSMD 260R	miniSMDC 260F	MF-MSMF 260	1812L 260TH	SMD1812P 260TFT
FSMD 260-13R	miniSMDC 260F/13.2	--	1812L 260/12	SMD1812P 260TF/12
FSMD 260-16R	miniSMDC 260F/16	--	1812L 260/16	SMD1812P 260TF/16
FSMD 300R	miniSMDC 300F	--	1812L 300	SMD1812P 300TFT
FSMD 005-1210-R	microSMD 005F	MF-USMF 005	1210L 005	SMD1210P 005TF
FSMD 010-1210-R	microSMD 010F	MF-USMF 010	1210L 010	SMD1210P 010TF
FSMD 020-1210-R	--	MF-USMF 020	1210L 020	SMD1210P 020TF
FSMD 035-1210-R	microSMD 035F	MF-USMF 035	1210L 035	SMD1210P 035TF
FSMD 050-1210-R	microSMD 050F	MF-USMF 050	1210L 050	SMD1210P 050TF
FSMD 075-1210-R	microSMD 075F	MF-USMF 075	1210L 075	SMD1210P 075TF
FSMD 075-24-1210R	--	--	1210L 075/24	SMD1210P 075TF/24
FSMD 110-1210R	microSMD 110F	MF-USMF 110	1210L 110	SMD1210P 110TFT
FSMD 110-16-1210R	--	--	1210L 110/16	SMD1210P 110TF/16
FSMD 150-1210R	microSMD 150F	MF-USMF 150	1210L 150	SMD1210P 150TFT
FSMD 175-1210R	microSMD 175F	MF-USMF 175	1210L 175	SMD1210P 175TF
FSMD 200-1210R	microSMD 200F	--	1210L 200	SMD1210P 200TF
FSMD 005-1206-R	--	--	1206L 005/60	SMD1206P 005TF
FSMD 010-1206-R	nanoSMDC 010F	--	1206L 010/60	SMD1206P 010TF
FSMD 012-1206-R	nanoSMDC 012F	MF-NSMF 012	1206L 012	SMD1206P 012TF
FSMD 016-1206-R	nanoSMDC 016F	MF-NSMF 016	1206L 016	SMD1206P 016TF
FSMD 020-1206-R	nanoSMDC 020F	MF-NSMF 020X	1206L 020	SMD1206P 020TF/24
FSMD 025-1206-R	nanoSMDC 025F	MF-NSMF 025X	1206L 025	SMD1206P 025TF
FSMD 025-24-1206-R	--	--	--	SMD1206P 025TF/24
FSMD 035-1206-R	nanoSMDC 035F	MF-NSMF 035X	1206L 035/16	SMD1206P 035TF/16
FSMD 035-30-1206R	--	--	1206L 035/30	SMD1206P 035TF/30
FSMD 050-1206-R	--	--	1206L 050	SMD1206P 050TF
FSMD 050-24-1206R	nanoSMDC 050F/13.2	MF-NSMF 050	1206L 050/15	SMD1206P 050TF/15
FSMD 075-1206R	nanoSMDC 075F	MF-NSMF 075	1206L 075TH	SMD1206P 075TFT
FSMD 075-16-1206R	--	--	1206L 075/16	SMD1206P 075TF/16
FSMD 100-1206R	--	--	--	--
FSMD 110-1206R	nanoSMDC 110F	MF-NSMF 110	1206L 110TH	SMD1206P 110TFT
FSMD 110-16-1206R	--	--	--	--
FSMD 150-1206R	nanoSMDC 150F	MF-NSMF 150	1206L 150TH	SMD1206P 150TFT
FSMD 200-1206R	nanoSMDC 200F	MF-NSMF 200	1206L 200	SMD1206P 200TF
FSMD 010-0805-R	picoSMDC 010S	MF-PSMF 010X	0805L 010	SMD0805P 010TF
FSMD 010-24-0805-R	--	MF-PSMF 010/24X	0805L 010/24	SMD0805P 010TF/24
FSMD 020-0805-R	picoSMDC 020S	MF-PSMF 020X	0805L 020	SMD0805P 020TF
FSMD 035-0805-R	picoSMDC 035S	MF-PSMF 035X	0805L 035	SMD0805P 035TF
FSMD 050-0805R	picoSMDC 050S	MF-PSMF 050X	0805L 050	SMD0805P 050TF
FSMD 050-9-0805R	--	--	--	--
FSMD 075-0805R	picoSMDC 075S	MF-PSMF 075X	0805L 075	SMD0805P 075TF
FSMD 100-0805R	--	--	0805L 100	SMD0805P 100TFT
FSMD 110-0805R	picoSMDC 110S	MF-PSMF 110X	0805L 110	SMD0805P 110TF
FSMD 001-0603-R	--	--	--	--
FSMD 002-0603-R	--	--	--	--
FSMD 003-0603-R	--	--	--	--
FSMD 004-0603-R	--	--	0603L 004	SMD0603P 004TF
FSMD 005-0603-R	femtoSMDC 005F	--	--	--
FSMD 008-0603-R	femtoSMDC 008F	--	--	--
FSMD 010-0603-R	femtoSMDC 010F	MF-FSMF 010X	0603L 010	SMD0603P 010TF
FSMD 012-0603-R	femtoSMDC 012F	--	--	--
FSMD 016-0603-R	femtoSMDC 016F	--	--	--
FSMD 020-0603-R	femtoSMDC 020F	MF-FSMF 020X	0603L 020	SMD0603P 020TF
FSMD 025-0603-R	--	MF-FSMF 025X	0603L 025	SMD0603P 025TF

Fuzetec		Tyco (Raychem)		Bourns		Littelfuse		Polytronics	
FSMD	050-1206RZ	--	--	--	--	--	--	SMD1206P	050SLR
FSMD	075-1206RZ	--	--	--	--	1206L	075SL	SMD1206P	075SLR
FSMD	110-1206RZ	--	--	--	--	1206L	110SL	SMD1206P	110SLR
FSMD	150-1206RZ	--	--	MF-NSML	150	1206L	150SL	SMD1206P	150SLR
FSMD	175-1206RZ	nanoSMD	175LR	MF-NSML	175	1206L	175SL	SMD1206P	175SLR
FSMD	200-1206RZ	nanoSMD	200LR	MF-NSML	200	1206L	200SL	SMD1206P	200SLR
FSMD	260-1206RZ	--	--	MF-NSML	260	1206L	260SLTH	SMD1206P	260SLR
FSMD	300-1206RZ	--	--	MF-NSML	300	1206L	300SLTH	SMD1206P	300SLR
FSMD	350-1206RZ	nanoSMD	350LR	MF-NSML	350	1206L	350SLTH	SMD1206P	350SLRT
FSMD	380-1206RZ	nanoSMD	380LR	MF-NSML	380	1206L	380SLTH	SMD1206P	380SLR
FSMD	400-1206RZ	nanoSMD	400LR	MF-NSML	400	1206L	400SL	SMD1206P	400SLR
FSMD	450-1206RZ	nanoSMD	450LR	MF-NSML	450	1206L	450SL	SMD1206P	450SLR
FSMD	500-1206RZ	nanoSMD	500LR	MF-NSML	500	--	--	SMD1206P	500SLR
FSMD	075-0805RZ	--	--	MF-PSML	075	0805L	075SL	SMD0805P	075SLR
FSMD	110-0805RZ	--	--	MF-PSML	110	0805L	110SL	SMD0805P	110SLR
FSMD	125-0805RZ	--	--	--	--	--	--	SMD0805P	125SLR
FSMD	150-0805RZ	--	--	MF-PSML	150	0805L	150SL	SMD0805P	150SLR
FSMD	175-0805RZ	--	--	MF-PSML	175	0805L	175SL	SMD0805P	175SLR
FSMD	200-0805RZ	--	--	MF-PSML	200	0805L	200SLTH	SMD0805P	200SLRT
FSMD	300-0805RZ	--	--	MF-PSML	300	0805L	300SL	SMD0805P	300SLRT
FSMD	350-0805RZ	--	--	MF-PSML	350	--	--	--	--
FSMD	025-0603RZ	--	--	MF-FSMF	025X	--	--	SMD0603P	025TF
FSMD	035-0603RZ	--	--	MF-FSMF	035X	--	--	SMD0603P	035TF
FSMD	050-0603RZ	--	--	MF-FSMF	050X	0603L	050SL	SMD0603P	050SLR
FSMD	075-0603RZ	--	--	--	--	0603L	075SL	SMD0603P	075SLR
FSMD	100-0603RZ	--	--	--	--	0603L	100SL	SMD0603P	100SLR
FSMD	010-0402RZ	--	--	--	--	0402L	010SL	SMD0402P	010SLR
FSMD	020-0402RZ	--	--	--	--	0402L	020SL	SMD0402P	020SLR
FSMD	035-0402RZ	--	--	--	--	0402L	035SL	SMD0402P	035SLR
FSMD	050-0402RZ	--	--	--	--	0402L	050SL	SMD0402P	050SLR
FSMD	0011-0201	--	--	--	--	zeptoSMDC	0011F	--	--
FSMD	0015-0201	--	--	--	--	zeptoSMDC	0015F	--	--
FSMD	0025-0201	--	--	--	--	--	--	--	--

Thermal Derating for PPTC Device at Various Ambient Temperatures.

FUZETEC PPTC Family	-40°C	-20°C	0°C	23°C	30°C	40°C	50°C	60°C	70°C	85°C	100°C	125°C
FRX-60/90	158%	138%	119%	100%	90%	81%	70%	60%	50%	36%	-	-
FRU	145%	130%	115%	100%	92%	84%	76%	70%	61%	50%	-	-
FRT	148%	134%	120%	100%	98%	90%	84%	78%	70%	59%	-	-
FUSB	145%	130%	115%	100%	91%	83%	78%	70%	61%	50%	-	-
FRG	148%	132%	116%	100%	91%	84%	76%	69%	60%	48%	-	-
FHT	143%	129%	116%	100%	93%	87%	80%	72%	65%	55%	-	26%
FHE	143%	130%	115%	100%	92%	88%	80%	72%	65%	55%	-	28%
FRHV	158%	138%	119%	100%	92%	83%	73%	64%	54%	40%	-	-
FRVL	158%	138%	119%	100%	90%	80%	70%	60%	50%	38%	-	-
FRV	150%	134%	116%	100%	90%	81%	74%	65%	58%	44%	-	-
FRV277	-	150%	125%	100%	90%	81%	70%	55%	48%	30%	-	-
FSMD-2920	145%	130%	115%	100%	92%	85%	78%	70%	62%	50%	-	-
FSMD-2016	157%	133%	118%	100%	90%	80%	70%	60%	51%	36%	-	-
FSMD-1812	145%	130%	116%	100%	91%	84%	78%	69%	61%	50%	-	-
FSMD-1210	145%	130%	115%	100%	92%	83%	76%	70%	62%	50%	-	-
FSMD-1206	145%	130%	115%	100%	92%	84%	78%	69%	62%	50%	-	-
FSMD-0805	145%	130%	116%	100%	91%	84%	76%	69%	61%	50%	-	-
FSMD-0603	157%	137%	118%	100%	89%	80%	70%	60%	51%	37%	-	-
FSMD-0402	145%	130%	115%	100%	92%	84%	77%	69%	61%	50%	-	-
FSMD-0201	157%	137%	118%	100%	89%	80%	70%	60%	51%	37%	-	-
FSMDH	135%	122%	110%	100%	-	90%	-	75%	-	65%	53%	40%
FSR	157%	137%	118%	100%	89%	80%	70%	60%	51%	37%	-	-
FLR	147%	132%	117%	100%	94%	86%	80%	71%	61%	52%	-	-
Low Rho FSMD-1206/0805/0603/0402	145%	130%	115%	100%	92%	84%	77%	69%	61%	50%	-	-

Pad Layouts 、 Solder Reflow Recommendations

The dimensions in the table below provide the recommended pad layout for Surface Mount Device in different footprints.

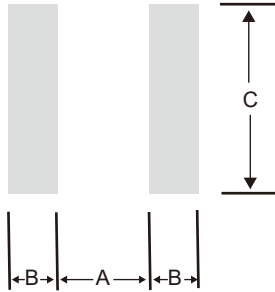

Pad dimensions (Millimeter)			
Device	A Nominal	B Nominal	C Nominal
All 2920 Series	5.10	2.30	5.60
All 2016 Series	3.60	1.80	4.60
All 1812 Series	3.45	1.78	3.50
All 1210 Series	2.00	1.00	2.80
All 1206 Series	2.00	1.00	1.90
All 0805 Series	1.20	1.00	1.50
All 0603 Series	0.80	0.60	0.80
All 0402 Series	0.40	0.60	0.70

Profile Feature	Pb-Free Assembly
Average Ramp-Up Rate (T _{smax} to T _p)	3°C/second max.
Preheat : Temperature Min (T _{smin}) Temperature Max (T _{smax}) Time (t _{smin} to t _{smax})	150°C 200°C 60-180 seconds
Time maintained above : Temperature(T _L) Time (t _L)	217°C 60-150 seconds
Peak/Classification Temperature(T_p) :	260°C
Time within 5°C of actual Peak : Temperature (t _p)	20-40 seconds
Ramp-Down Rate :	6°C/second max.
Time 25°C to Peak Temperature :	8 minutes max.

Solder reflow

※ Due to "Lead Free" nature, Temperature and Dwelling Time for the soldering zone is higher than those for Regular. This may cause damage to other components.

1. Recommended max paste thickness is 0.25mm.(Nominal)
2. Devices can be cleaned using standard methods and aqueous solvent.
3. Rework use standard industry practices.
4. Storage Environment : < 30°C / 60% RH

Caution :

1. If reflow temperatures exceed the recommended profile, devices may not meet the performance requirements.
2. Devices are not designed to be wave soldered to the bottom side of the board

Note 1 : All temperatures refer to the package, measured on the package body surface.

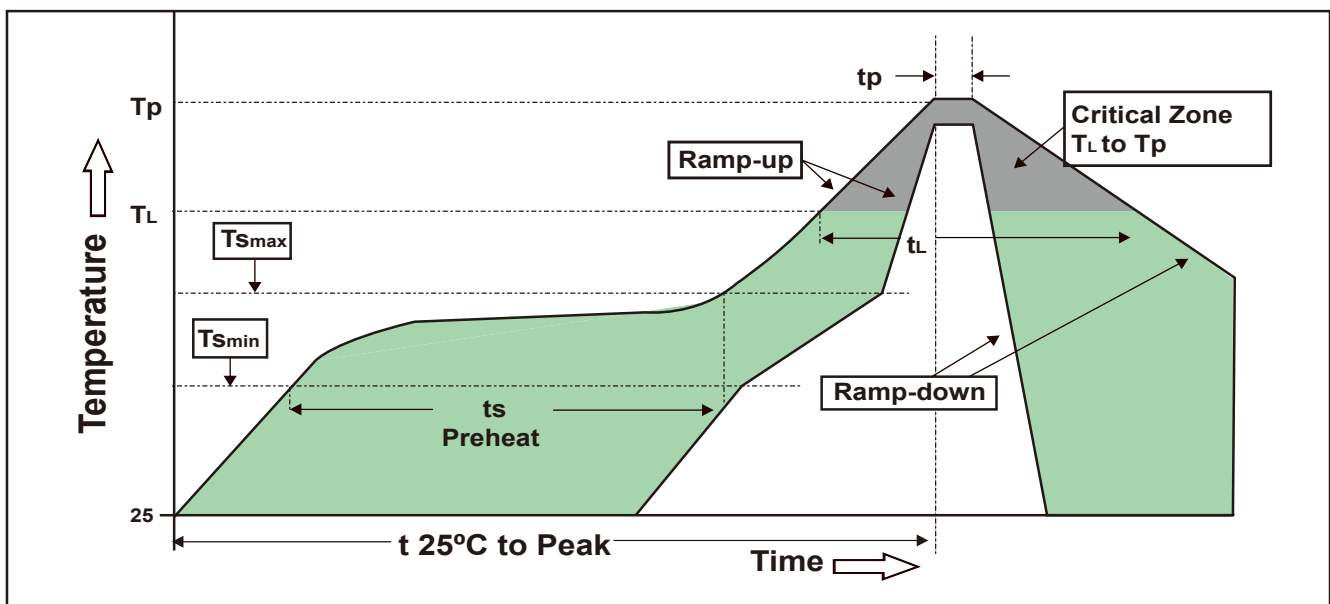

Pad Layouts 、 Solder Reflow and Rework Recommendations

The dimensions in the table below provide the recommended pad layout for Surface Mount Device in different footprints.

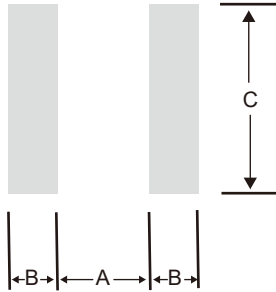

Pad dimensions (Millimeter)			
Device	A Nominal	B Nominal	C Nominal
All FSMD0201 Series	0.250	0.325	0.450

Profile Feature	Pb-Free Assembly
Average Ramp-Up Rate (T_{smax} to T_p)	1-3°C/second max.
Preheat : Temperature Min (T _{smin}) Temperature Max (T _{smax}) Time (t _{smin} to t _{smax})	130°C 180°C 90-110 seconds
Time maintained above : Temperature(T _L) Temperature(T _L) Time (t _L)	≤2 °C/second max. 217°C 60-70 seconds
Peak/Classification Temperature (T _p) :	240°C
Time within 5°C of actual Peak : Temperature (t _p)	35 seconds
Ramp-Down Rate :	2~4°C/second
Time 25°C to Peak Temperature :	300 minutes max.

Solder reflow

※ Due to "Lead Free" nature, Temperature and Dwelling Time for the soldering zone is higher than those for Regular. This may cause damage to other components.

1. Recommended max paste thickness is 0.25mm.(Nominal)
2. Devices can be cleaned using standard methods and aqueous solvent.
3. Rework use standard industry practices.
4. Storage Environment : < 30°C / 60% RH

Caution :

1. If reflow temperatures exceed the recommended profile, devices may not meet the performance requirements.
2. Devices are not designed to be wave soldered to the bottom side of the board

Note 1 : All temperatures refer to the package, measured on the package body surface.

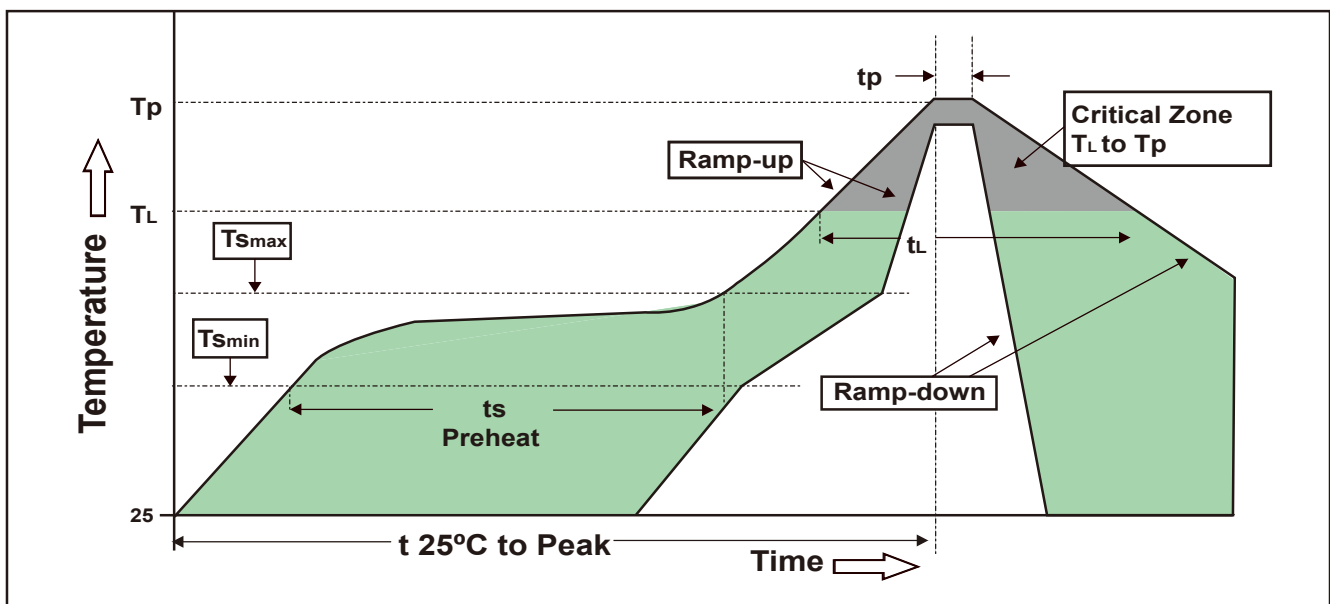

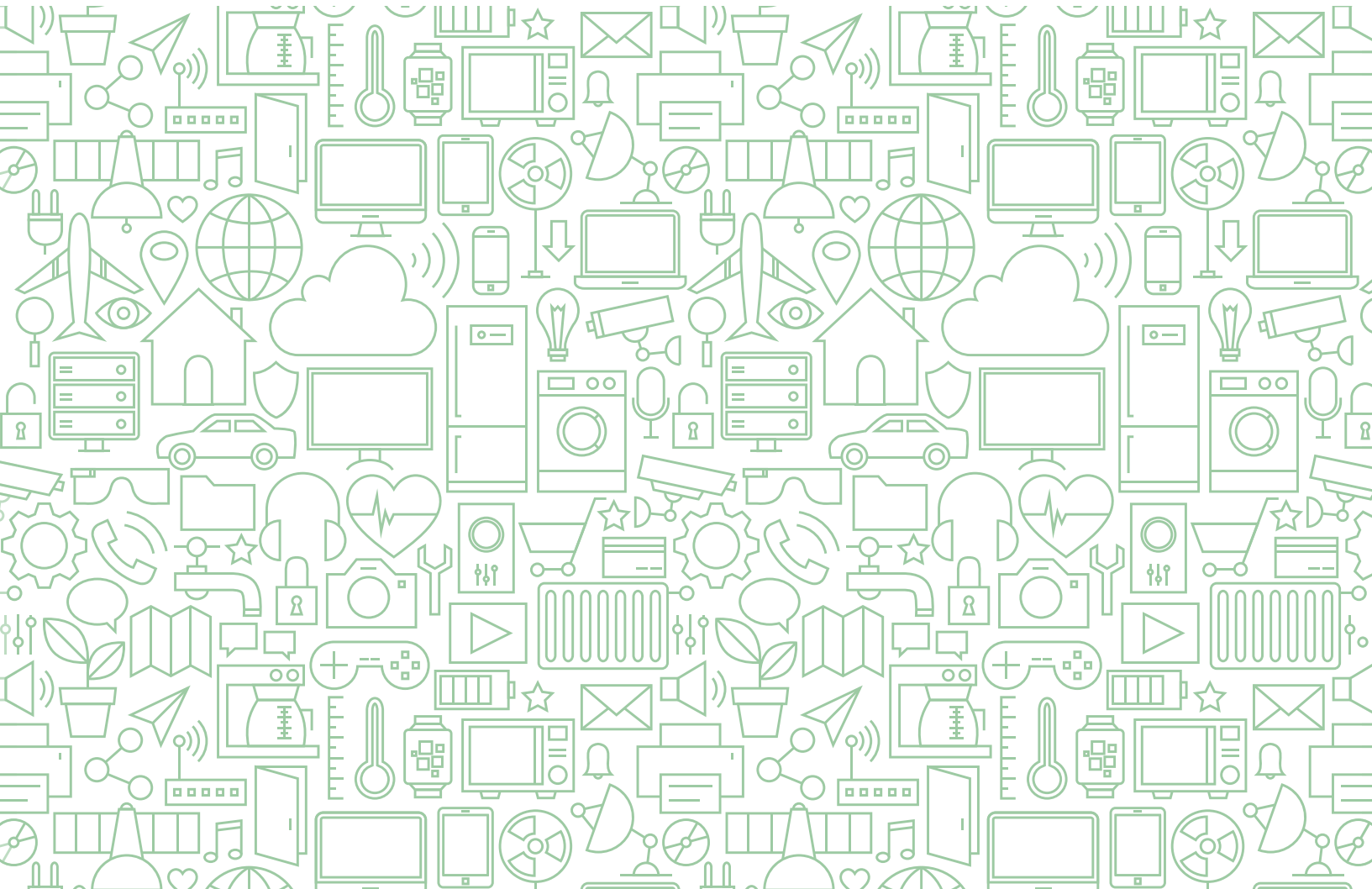

FUZETEC

FUZETEC TECHNOLOGY CO., LTD.

**No.60, Wu-Gong 5 Road, Wu Gu Dist.,
New Taipei City, Taiwan 24890**

TEL: 886 2 8990 2113 FAX: 886 2 8990 2110

E-mail: mail@fuzetec.com.tw

Website: www.fuzetec.com

富致科技股份有限公司

24890 新北市五股區五工五路60號

Agent